

# EXACTECH | KNEE

Operative Technique



**TRULIANT®**

Primary Total Knee System

TABLE OF CONTENTS

INTRODUCTION.....1

DETAILED OPERATIVE TECHNIQUE .....2

    Approach and Exposure.....2

    Distal Femoral Resection .....2

    Tibial Alignment and Resection .....6

    Extension Gap Assessment ..... 11

    Femoral Rotation and Sizing - A/P Sizer ..... 12

    Final Femoral Preparation..... 13

    Trial Reduction..... 19

    Final Tibial Preparation.....23

    Patella Preparation and Sizing.....28

    Final Implantation.....30

    Final Check and Closure.....35

    General Notes.....35

APPENDIX .....36

INSTRUMENT LISTING .....62

TRAY LAYOUTS.....76



## INTRODUCTION

With knee arthroplasty continuing to grow, orthopaedic surgeons are challenged to deliver superior clinical outcomes with ever greater efficiency. The Truliant® Primary Knee System offers a high-performance, comprehensive platform that offers solutions to address clinical challenges in total knee replacement. Leveraging Exactech's core principles, Truliant applies advanced design philosophies and surgical technologies to help you deliver reproducible clinical outcomes.

## DETAILED OPERATIVE TECHNIQUE

### APPROACH AND EXPOSURE

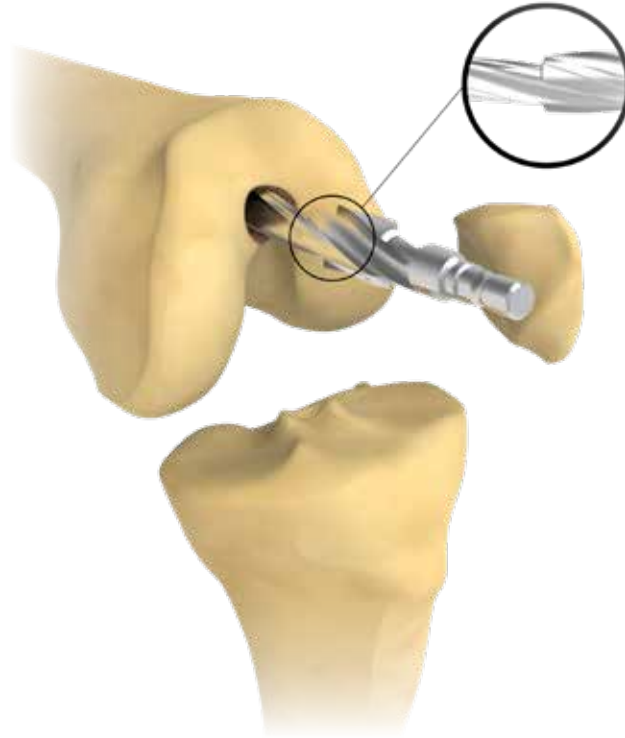

**Figure 1**

Enter Intra-Medullary Canal with the IM Pilot Drill

---

### APPROACH AND EXPOSURE

Incision and exposure should be performed using the surgeon's preferred technique.

### DISTAL FEMORAL RESECTION

#### Opening of the Intra-medullary Canal

The **Intra-medullary (IM) Pilot Drill** should be used to drill a hole in the distal femur coaxially with the femoral endosteal canal (*Figure 1*). The entry point for this drill is located in the intercondylar groove 5-10mm superior to the intercondylar notch.

The stepped pilot drill design can be used to enlarge the hole in the distal femur while drilling so that a slightly malpositioned entrance point does not affect the alignment of the **IM Rod**. After the canal has been opened with the IM Pilot Drill, the IM Rod should be inserted into the femoral canal, ensuring it passes easily. The IM Rod may then be removed from the canal with the **Modular T-Handle** or left in place while only the Modular T-Handle is removed.

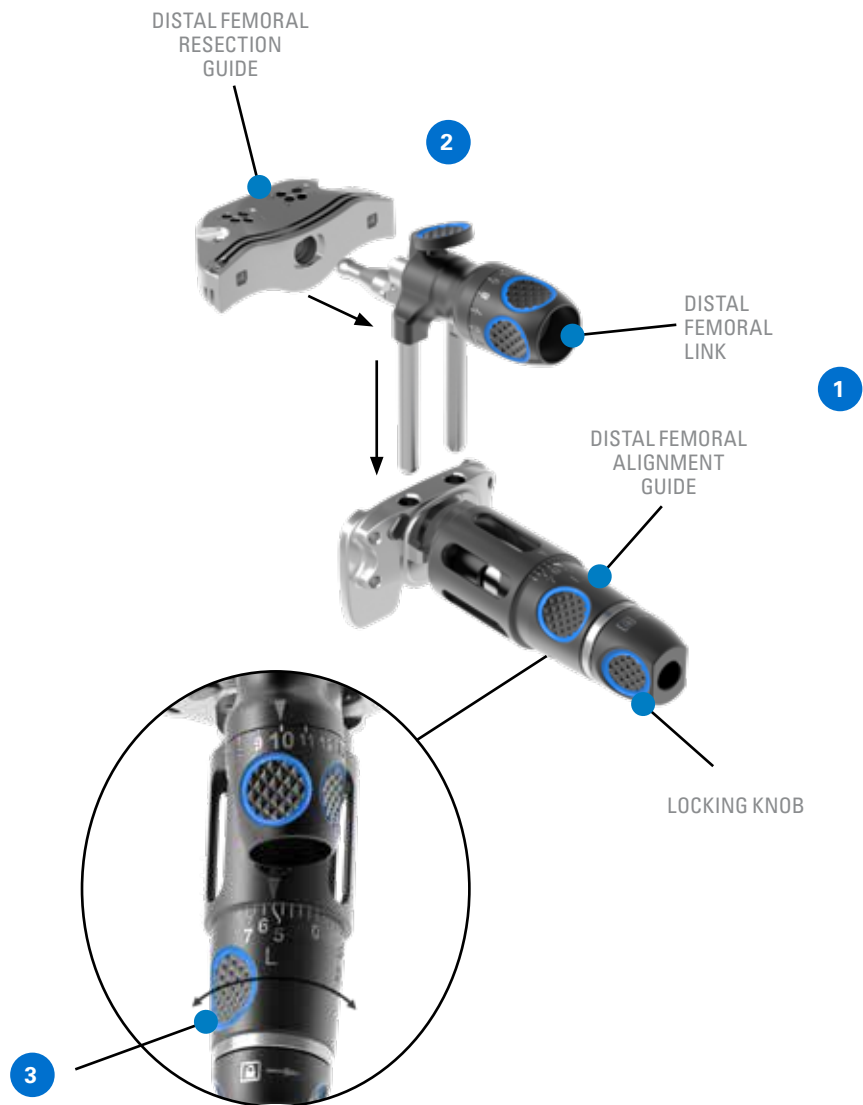

### Instrument Assembly

1. Insert the **Truliant Distal Femoral Link** into the **Truliant Distal Femoral Alignment Guide**
2. Affix the **Truliant Distal Femoral Resection Guide** to the Distal Link
3. Set the desired valgus angle of the femoral cut by turning the dial on the alignment guide to the proper side (left or right) and set to the desired number from 0 to 9 degrees

## DETAILED OPERATIVE TECHNIQUE

### DISTAL FEMORAL RESECTION



**Figure 2**

Align Distal Femoral Cutting Assembly on Distal Femur



**Figure 3**

Set the Distal Femoral Resection Depth

Place the Truliant Modular T-Handle IM Rod through the hole in the Alignment Guide and introduce the assembly onto the distal femur (Figure 2).

**Note:** The knob on the end of the Alignment Guide will lock the position of the assembly on the IM Rod if desired.

Set the depth of the distal femoral resection by turning the dial on the Distal Link from 1 to 14mm in 1mm increments (Figure 3).

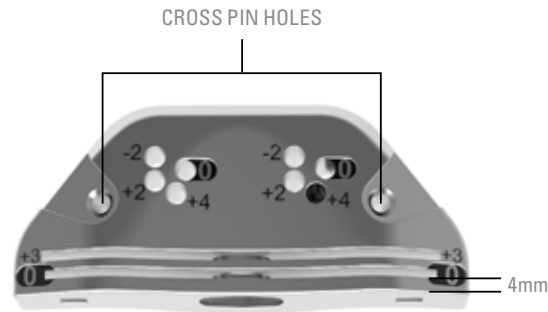

**Figure 4**  
Distal Femoral Resection Guide

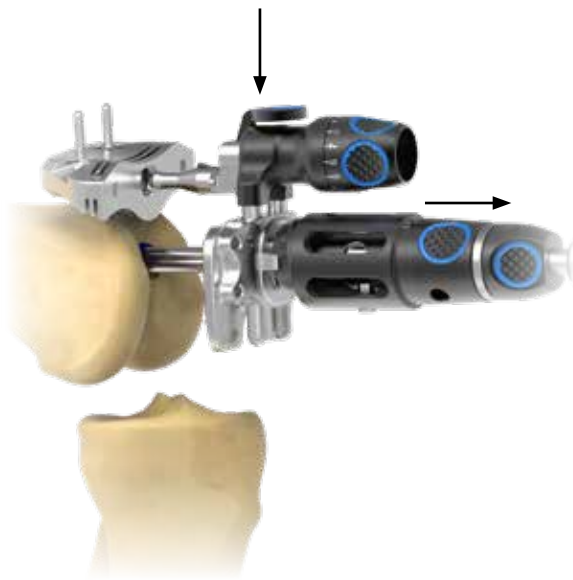

**Figure 5**  
Removal of Distal Femoral Cutting Assembly

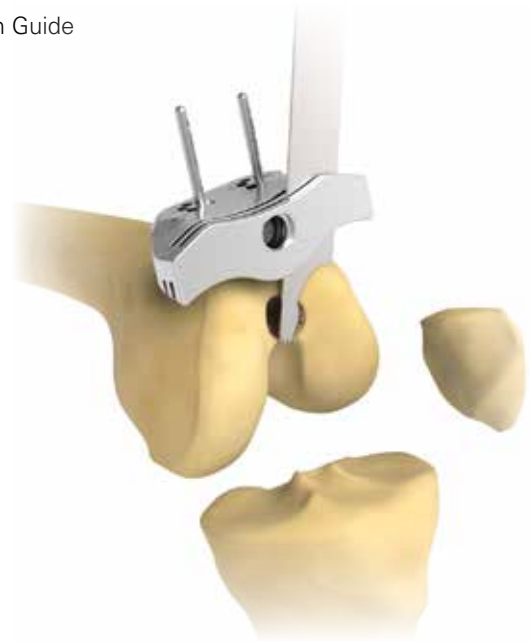

**Figure 6**  
Distal Femoral Resection

The Resection Guide can be rotated around the attachment peg to better fit the anatomy of the bone. Avoid excessive rotation which may cause the pins to interfere with the IM Rod.

Pin the Resection Guide in the "0" holes. The Resection Guide features shift pin holes and an alternate cutting slot for fine-tuning the resection depth after pinning ( $\pm 2$ mm and +4mm pin holes and +3mm alternate cutting slot). Two cross pin holes are available for additional stability of the Resection Guide. If the distal flat surface of the Resection Guide is used for resection, 4mm less bone will be resected than the standard slot (*Figure 4*). A resection of 8 to 10mm is typical and an 8mm resection will match the thickness of the implant.

Remove the Modular T-Handle and IM Rod, Distal Link, and Alignment Guide all together by pressing the button on top of the Distal Link and pulling the assembly off the bone (*Figure 5*). The distal femoral resection is performed (*Figure 6*).

**Note:** 1.27mm saw blades are recommended for all Truliant resection guides.

The Resection Guide should now be removed.

## DETAILED OPERATIVE TECHNIQUE

### TIBIAL ALIGNMENT AND RESECTION

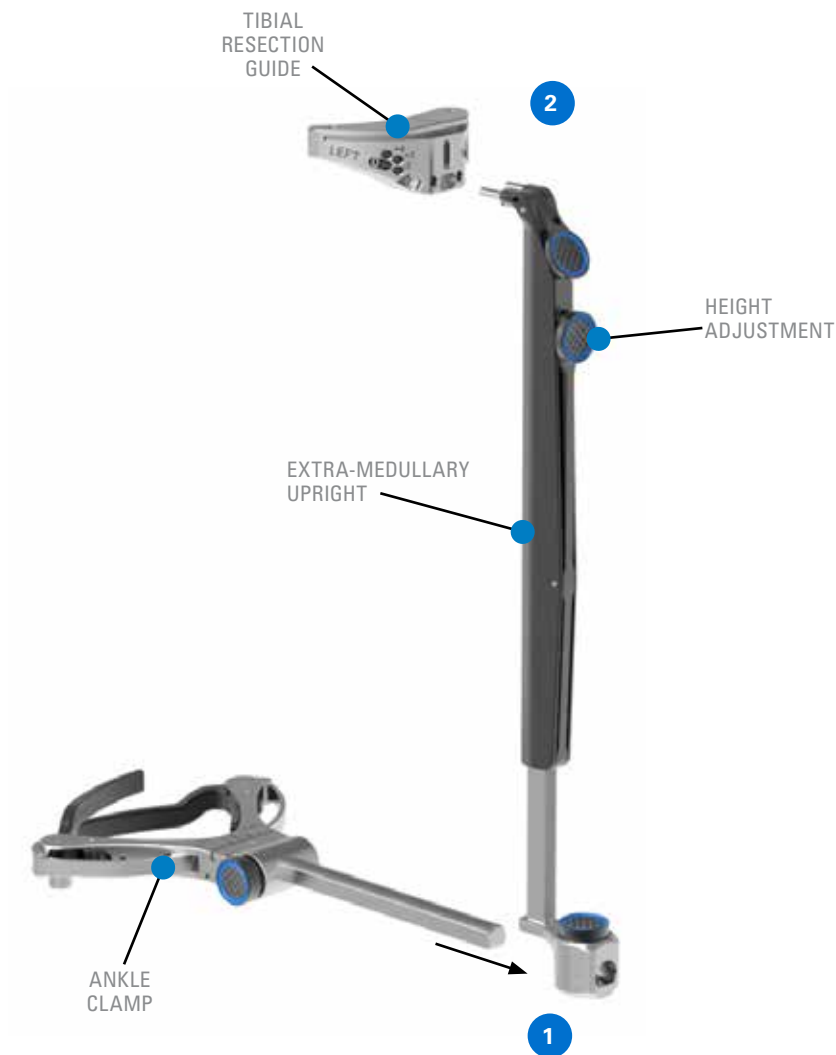

### TIBIAL ALIGNMENT AND RESECTION

An Intra-medullary Guide is available as an alternative to the Extra-medullary (EM) Tibial Alignment Guide. Please reference Appendix A in the back of this operative technique for information.

### Instrument Assembly

#### Extra-medullary (EM) Tibial Alignment Guide

1. Slide the shaft of the **Truliant Ankle Clamp** into the lower end of the **Truliant EM Upright** while pressing the button. The markings on the Ankle Clamp should face upward.
2. Attach the **Truliant Tibial Resection Guide** to the Upright by pressing the most proximal button on the Upright.

Pressing the vertical button on the Upright will allow the height of the Upright to be adjusted. Releasing the button will lock the height in place.





**Figure 7**

Placement of Extra-medullary Tibial Alignment Guide



**Figure 8**

Center Distal End of EM Tibial Alignment Guide Over the Ankle Joint

Open the two arms of the Ankle Clamp until the triggers self-lock. With the arms of the Ankle Clamp in the open position, push instrument assembly against the tibia, triggering the arms to close around the ankle joint in the supra-malleolar position (*Figure 7*).

The position of the EM Tibial Alignment Guide can be adjusted by pressing the button on the Ankle Clamp and shifting the EM Tibial Alignment Guide medially or laterally (*Figure 8*). The distal end of the EM Tibial Alignment Guide should be centered over the ankle joint. In most instances, the Ankle Clamp will read 2-5mm medial when properly placed.

Landmarks to center the Tibial Resection Guide proximally include the medial 1/3 of the anterior tibial tuberosity and tibial spine. In the sagittal plane, the tibial axis can be referenced as a line extending from the center of the knee joint to the center of the ankle joint.

## DETAILED OPERATIVE TECHNIQUE

### TIBIAL ALIGNMENT AND RESECTION



**Figure 9**  
Adjust Tibial Posterior Slope



**Figure 10**  
Place the Truliant Adjustable Tibial Stylus in the Truliant Tibial Resection Guide

The posterior slope of the Tibial Resection Guide can be adjusted by shifting the Upright on the Ankle Clamp along the AP direction. Push the distal button on the Upright to shift its AP position and the slope of the Tibial Resection Guide, and release the button to lock the selected slope angle (Figure 9). When setting up the sagittal orientation of the proximal tibial cut, a neutral posterior slope of 0 to 3 degrees is recommended. It is important to avoid anterior slope and excessive posterior slope.

**Note:** It is recommended to start the position of the Upright approximately half way on the shaft of the ankle clamp (or 3-4 fingers width from the tibia) and adjust as needed from there.

Once the desired slope has been set, the **Truliant Adjustable Tibial Stylus** can be used to set the resection height. Place the foot of the Tibial Stylus into the cutting slot of the Tibial Resection Guide. The resection level can be adjusted by turning the dial on the top of the Adjustable Stylus to the desired depth (ranging from 0 to 14mm) (Figure 10). Adjust the height of the Upright so that the Adjustable Stylus references the targeted tibial plateau.



**Figure 11**

Assess Alignment with Extra-Medullary Landmarks



**Figure 12**

Truliant Tibial Resection Guide

The **Truliant Cut Line Predictor** may be used to evaluate the tibial resection level and slope. Once the Tibial Resection Guide is adjusted to the desired resection level and slope, it can be pinned in position. Drill pins should be placed in the “0” holes.

**Optional Verification:** Once the Tibial Resection Guide is properly positioned, the alignment of the resection guide can be verified by inserting the **Alignment Rod Handle** into the slot of the Tibial Resection Guide. The **Alignment Rod** can then be placed through the holes or slot in the handle and used to assess alignment with extra-medullary landmarks (*Figure 11*).

After pinned through the “0” holes, the Tibial Resection Guide may be adjusted proximally or distally in 2mm increments by shifting the Tibial Resection Guide onto either the -2mm, +2mm, or +4mm shift holes. If the resection is performed on the proximal flat surface of the Tibial Resection Guide, it resects 4mm less bone than if using the cut slot (*Figure 12*). Cross pin holes are also available on the Tibial Resection Guide for additional stability during bone resection.

**Optional Instrumentation is available** for making a 2-degree varus/valgus re-cut or a 2mm re-cut. Please reference Appendix B in this operative technique.

## DETAILED OPERATIVE TECHNIQUE

### TIBIAL ALIGNMENT AND RESECTION



**Figure 13**  
Placement of PCL Retractor



**Figure 14**  
Determine Tibial Resection Depth

#### **Optional Posterior Cruciate Referencing Technique (PCRT) for CR Procedure**

The PCRT surgical technique offers the ability to set the tibial resection depth while ensuring the integrity of the posterior cruciate ligament (PCL) insertion on the posterior tibia. Place the **PCL Retractor** behind the tibia with one prong medial and one prong lateral to the PCL. Subluxate the posterior margin of the tibia anterior to the femur. At this point the PCL Retractor should protect both the PCL and the resected surface of the distal femur (when a femur-first sequence is used) (*Figure 13*). Release any connective and/or scar tissues typically present around the anterior aspect of the tibial insertion of the PCL until the fibers of the PCL are recognized at their insertion into the posterior tibia. It is also advisable to resect any remaining posterior horns of both menisci and menisco-femoral ligaments.

The Truliant EM Tibial Alignment Guide, Tibial Resection Guide, and Tibial Stylus are placed as described previously.

In the PCRT approach, extend the stylus to reach the posterior aspect of the tibial plateau and place the tip of the stylus at the insertion point of the PCL, providing a direct reference of the ligament's insertion (*Figure 14*). With the Stylus set at 0mm, the tibial resection is aligned exactly to the tip of the stylus. Setting the stylus to another number will indicate the amount of additional distal tibial resection from the tip of the stylus. It is recommended to set the Stylus at 2mm, resulting in a tibial resection that is 2mm below the tip of the stylus.



**Figure 15**  
Gap Assessment in Extension with Spacer Block

A neutral tibial slope between 0 and 3 is recommended for the PCRT approach. Increasing the posterior tibial slope (beyond 5 degrees) may damage tibial insertion of the PCL. Excessive posterior tibial slope of the insert can result in accelerated wear of the posterior aspect of the tibial insert.

Once the desired position of the Tibial Resection Guide is achieved, pin the guide in the "0" holes and proceed to make the proximal tibial resection as described previously.

#### EXTENSION GAP ASSESSMENT

Check the extension gap by fully extending the leg and placing the appropriate end of the **Truliant Spacer Block** between the two resected surfaces (*Figure 15*).

The 9/11mm Spacer Block connects to a 1mm shim on both ends to evaluate 10 and 12mm thicknesses.

The 13/15mm Spacer Block also connects to a 4mm shim on both ends to evaluate 17 and 19mm thicknesses.

Soft tissue releases and additional bone resections can be performed to achieve the desired extension gap.

**Note:** The Spacer Block can also be used to assess the flexion space after placement of the **Truliant Femoral Finishing Guide** or after resection of the posterior condyles. Use a Spacer Block that is 4mm less than the intended flexion space (as the distance between the posterior cutting slot and posterior surface of the Femoral Finishing Guide is 4mm).

If desired, the Alignment Rod can be placed through the holes or the slot in the Spacer Block to assess alignment.

## DETAILED OPERATIVE TECHNIQUE

### FEMORAL ROTATION AND SIZING - A/P SIZER

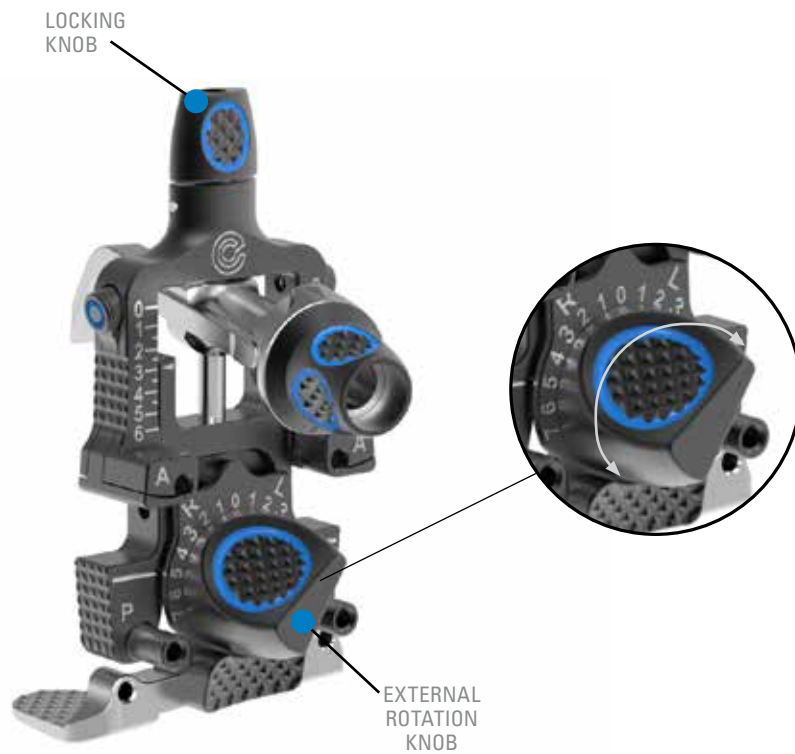

**Figure 16**  
A/P Sizer

**Optional Ligament Balance System instrumentation (LBS-3)** is available. Please reference Appendix C of this operative technique.

#### FEMORAL ROTATION AND SIZING

##### A/P Sizer

The **Truliant A/P Sizer** (Figure 16) will accommodate both Anterior Referencing and Posterior Referencing techniques. Choosing the Anterior Referencing pin holes will provide a constant anterior cut as a reference, regardless of size. All variation in bone cuts from one size to the next will occur on the posterior cut. When using the Anterior Referencing pin holes, changing the size of the femoral component will alter the posterior condyle resection and therefore the flexion space. When using the Posterior Referencing pin holes, changing the size of the femoral component will alter the

anterior resection level thus increasing or decreasing the risk of anterior notching.

Alternately, choosing the Posterior Referencing pin holes will provide a constant posterior cut regardless of size. All variation in bone cuts from one size to the next will occur on the anterior cut. External femoral rotation can be set by adjusting the dial on the front of the A/P Sizer to either left or right from 0 to 7 degrees in 1 degree increments.

##### Femoral Rotation and Sizing

The A/P Sizer should be placed flush against the resected distal surface of the femur. The posterior feet of the A/P Sizer should be inserted under the posterior femoral condyles. If a posterior condylar defect is present, the A/P Sizer should be rotated to a position that accommodates the defect. If desired, secure the A/P Sizer with a headed pin through the fixation hole on the posterior feet. The horizontal line marked

## DETAILED OPERATIVE TECHNIQUE

### FINAL FEMORAL PREPARATION



**Figure 17**

Place Femoral A/P Sizer on Distal Femur and Pin in Place

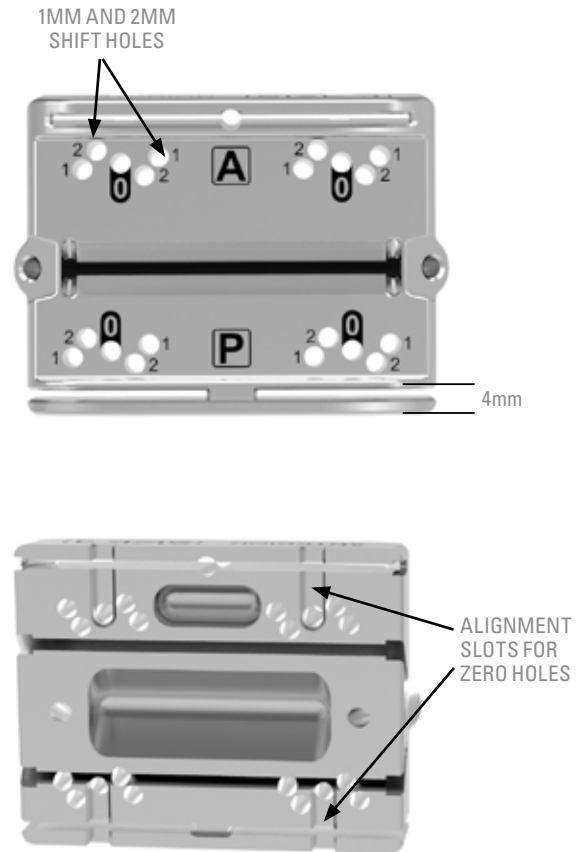

**Figure 18**

Truliant Femoral Finishing Guide

on the body of the A/P Sizer and the vertical shaft can be used as references to check anatomical alignment against the transepicondylar axis (TEA) and Whiteside's line of the distal femur. The A/P Sizer is adjusted to the femoral size. The tip of the A/P Sizer Stylus should be positioned underneath the quadriceps and into the suprapatellar pouch. To adjust the position of the stylus, turn the dial to the size corresponding to the femoral size reading on the front of the A/P Sizer (Figure 17). Verify that the A/P Sizer is flush against the distal femoral surface, and pin the A/P sizer using non-headed drill pins in either the pin holes marked with an "A" for Anterior Referencing or the pin holes marked with a "P" for Posterior Referencing (Figure 17). The knob on the top of the A/P Sizer can be used to lock the body position. The A/P Sizer should then be removed from the bone, leaving the two alignment pins in place. If using the Anterior Referencing pin holes, push the two buttons on either side of the main body to release the pins from the "A" pin holes.

**Note:** Rotating the stylus away from the trochlea can help with removal of the A/P Sizer.

### FINAL FEMORAL PREPARATION

#### Truliant Femoral Finishing Guide

Consistent with the A/P Sizer, the Truliant Femoral Finishing Guide will accommodate both Anterior Referencing and Posterior Referencing techniques and has identical M/L dimension as the corresponding femoral component.

The Truliant Femoral Finishing Guide allows for fine-tuning of the A/P position of the femoral component by either 1 or 2mm through the use of shift holes (Figure 18).

**Note:** The Truliant femoral components increase in size by 2mm on average in the A/P direction. Thus the shift holes can also be used to predict the resection when up-sizing or down-sizing.



## DETAILED OPERATIVE TECHNIQUE

### FINAL FEMORAL PREPARATION



**Figure 19**

Placement of Femoral Finishing Guide



**Figure 20**

Assessment of Flexion Space Using a Spacer Block

#### Placement of Femoral Finishing Guide and Resection

Select the size of the Femoral Finishing Guide that matches the femur size indicated by the A/P Sizer and position it onto the alignment pins left in the distal femur from the previous sizing step. The alignment slots on the backside of the Femoral Finishing Guide can be used to slide the pins into the "0" pin holes (*Figure 19*). If the Anterior Referencing technique is being followed, the zero pin holes labeled "A" should be utilized. Conversely, if the Posterior Referencing technique is being followed, the zero holes labeled "P" should be utilized.

**Note:** When using the Anterior Referencing pin holes, changing the size of the femoral component will alter the posterior condyle resection and therefore the flexion space. When using the Posterior Referencing pin holes, changing the

size of the femoral component will alter the anterior resection level thus increasing or decreasing the risk of anterior notching.

The flexion space can be checked prior to bone resection by using a spacer block placed below the bottom flat surface of the Femoral Finishing Guide (*Figure 20*). The distance between the posterior slot and the bottom of the Femoral Finishing Guide is 4mm, thus the spacer block selected should be 4mm less than the target space. The Truliant Cut Line Predictor can be used to help assess the position of the Femoral Finishing Guide during this fine-tuning step.





**Figure 21**

Pin the Femoral Finishing Guide with Two Headed Pins

---

Once the Femoral Finishing Guide is properly positioned, secure it by inserting two headed pins into the cross pin holes on the side (*Figure 21*).

Ensure the Femoral Finishing Guide is securely fixed and stays flush against the distal femur. The sizing alignment pins should then be removed and the anterior and posterior cuts are performed followed by the chamfer cuts. Once the cuts on the distal femur have been completed, the Femoral Finishing Guide and pins are be removed.

## DETAILED OPERATIVE TECHNIQUE

### FINAL FEMORAL PREPARATION

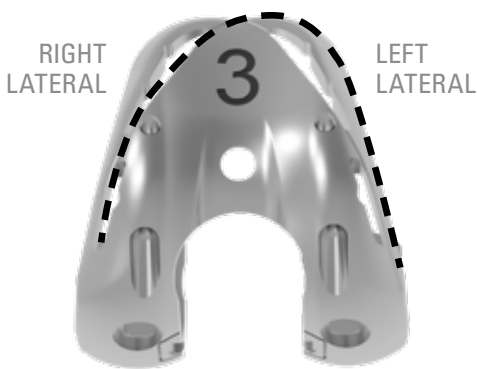

**Figure 22**  
Truliant Femoral Trial



**Figure 23**  
Place Femoral Trial Using Locking Femoral Impactor

#### Femoral Trial Placement and PS Notch Preparation

Select the **Truliant Femoral Trial** that corresponds to the previously determined femoral component size. The reference windows on the Femoral Trial can be used to view the outer profile of the implant for the right and left components (Figure 22).

Using the **Truliant Locking Femoral Impactor** (Figure 23), place the femoral trial on the distal femur ensuring proper M/L position of the femoral component. Apply slight upward pressure to the **Modular Handle** as the component is being positioned to prevent the femoral component from going into flexion during impaction. Once correct positioning is assured, the component should be fully seated by striking the end of the Modular Handle with a mallet. The Locking Femoral Impactor/Modular Handle assembly can then be removed.

**Note:** If a Truliant CR implant is selected, proceed to the next section, Trial Reduction. If a Truliant PS implant is selected, continue to PS Notch Preparation.



**Figure 24**

Assembly of Notch Guide to Femoral Trial



**Figure 25**

Prepare PS Notch

### PS Notch Preparation

Assemble the **Truliant PS Notch Guide** to the Femoral Trial already on the bone by sliding the two rods on the Notch Guide into the corresponding two holes on the Femoral Trial until it is fully seated and a “click” is heard (*Figure 24*).

For added stability during notch preparation, pins can be placed into the flange pin holes on the femoral trial. Attach the **Truliant Notch Cutter** that corresponds to the Femoral Trial and Notch Guide size to a power drill. With the knee in flexion, introduce the Notch Cutter into the Notch Guide, making sure that the drill is set on “drill” setting. Once the teeth on the Notch Cutter have cleared the black bushing and before the teeth contact the bone, activate the drill. Apply pressure to the Notch Cutter as it travels posteriorly and ream until the Notch Guide prevents the Notch Cutter from further travel (*Figure 25*).

## DETAILED OPERATIVE TECHNIQUE

### FINAL FEMORAL PREPARATION



**Figure 26**

Remove Bone Remnants from the Distal Femur

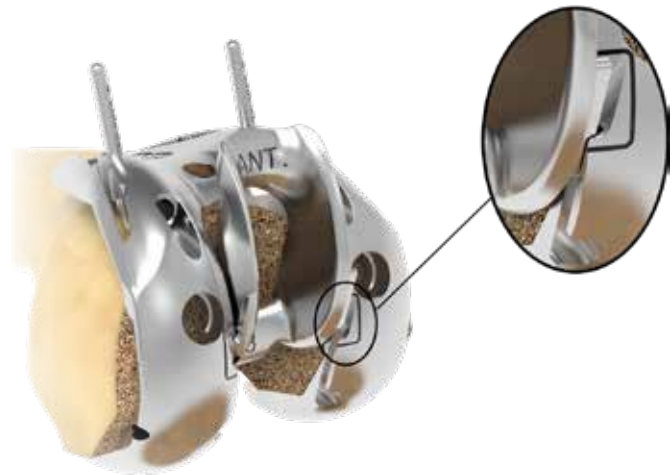

**Figure 27**

Assembly of PS Cam Trial to Femoral Trial

Turn the power drill off, and remove the Notch Cutter from the Notch Cutting Guide. Be sure not to activate the drill while removing the Notch Cutter in order to prevent the cutting teeth from scoring the black bushing. Remove the Notch Guide from the Femoral Trial.

Due to the cylindrical shape of the Notch Cutter, it is necessary to remove any existing bone remnants from the distal femur (*Figure 26*). Use a sagittal saw to remove the bone remnants, aligning the saw to the inner surfaces of the Femoral Trial and fully trim the medial and lateral sides of the notch. Any remnant bone left at the notch could affect the placement of the **PS Cam Trial** and the final implantation.

At this stage the Truliant PS Cam Trial can be assembled into the Femoral Trial. Select the corresponding size Cam Trial and slide it into the Femoral Trial from anterior to posterior, ensuring proper alignment of the rails of the Cam Trial with the slots on the Femoral Trial (the entry location is highlighted by markings). Push the Cam Trial into place with a finger until fully seated and "clicks" into place (*Figure 27*). With proper initial alignment, no impaction is needed on the Cam Trial.



**Figure 28**  
Positioning of the Tibial Baseplate Trial



**Figure 29**  
Assembly of Tibial Insert Trial Shim with Tibial Insert Top

Color	Femoral Trial Size	Tibial Insert Trial Top Size	Tibial Insert Trial Shim Size	Baseplate Trial Options		
				down size	same size	up size
Orange*	0	0	0	—	0T	1T
Black	1	1	1-2.5	0T/0.5T	1T	1.5T/2T
Grey	1.5	1.5	1-2.5	0.5T/1T	1.5T	2T/2.5T
Blue	2	2	1-2.5	1T/1.5T	2T	2.5/3T
Light Blue	2.5	2.5	1-2.5	1.5T/2T	2.5T	3T/3.5T
Brown	3	3	3-4.5	2T/2.5T	3T	3.5/4T
Light Brown	3.5	3.5	3-4.5	2.5T/3T	3.5T	4T/4.5T
Green	4	4	3-4.5	3T/3.5T	4T	4.5T/5T
Light Green**	4.5	4.5	3-4.5	3.5T/4T	4.5T	5T
Purple	5	5	5/6	4T/4.5T	5T	6T
Yellow*	6	6	5/6	5T	6T	—

\*Special order

**Table 1**  
Trial Size Compatibility

**TRIAL REDUCTION**

**Tibial Trial Components**

The **Truliant Tibial Baseplate Trial** should be selected as the largest baseplate that fits within the borders of the resected tibial surface without any overhang (*Figure 28*). The Baseplate Trial selected should be consistent with the Trial Size Compatibility Chart (*Table 1*).

Next, the appropriate thickness of **Truliant Tibial Insert Trial Shim** should be assembled to the desired **Truliant Tibial Insert Trial Top** (PS, PSC, CR or CRC) (*Figure 29*). The Tibial Insert Trial Shims and Top should match the selected femoral component size. See *Table 1* for size compatibility.

## DETAILED OPERATIVE TECHNIQUE

### TRIAL REDUCTION



**Figure 30**

Assemble Tibial Insert Trial Shim with Trial Top to Baseplate Trial using the Tibial Trial Handle



**Figure 31**

Assess Alignment

The **Truliant Tibial Trial Handle** should then be inserted into the Shim/Top combination and placed on the Tibial Baseplate Trial (*Figure 30*). To adjust the thickness of the Tibial Insert Trial Assembly, the Shim can be exchanged as needed using the Tibial Trial Handle until a “best fit” is achieved.

#### **Alignment Check**

With the knee in full extension and the Trial Handle assembled to the Tibial Baseplate Trial, an EM Alignment Rod can be placed in the holes or the slot of the Tibial Trial Handle and the alignment can be assessed (*Figure 31*). Proper rotation of the tibial component should be determined by its congruency with the femoral component. Normally, the anterior plane of the tibial component will point approximately in the direction of the tibial tubercle and second toe when congruency is established.

#### **Stability Check**

The knee should be assessed for stability in both extension and flexion.



**Figure 32**  
Check Motion in Extension



**Figure 33**  
Check Motion in Flexion

---

**Motion Check**

The knee should extend fully without force (*Figure 32*).

To check flexion the surgeon should elevate the thigh and allow the leg to flex by the pull of gravity (*Figure 33*).

## DETAILED OPERATIVE TECHNIQUE

### TRIAL REDUCTION



**Figure 34**  
Prepare CR Femoral Peg Hole



**Figure 35**  
Removal of Femoral Trial with Femoral Trial Extractor

After final ROM assessment, for the Truliant CR implant, use the **Truliant CR Peg Drill** to drill through the medial and lateral holes on the Femoral Trial (*Figure 34*). This will create the space required to accommodate the pegs on the Truliant CR femoral implant. Now the Femoral Trial and Tibial Insert Trial Assembly can be removed.

The Truliant Femoral Trial should be removed using the **Femoral Trial Extractor** assembled to the **Truliant Slap Hammer**. Pull the sleeve of the Femoral Trial Extractor back and engage the feet into the peg holes (*Figure 35*). Release the sleeve and remove the Femoral Trial by striking the Slap Hammer.

**Note:** Do not use the Femoral Trial Extractor for femoral trial impaction. Such misuse could damage both the Femoral Trial and the Extractor.



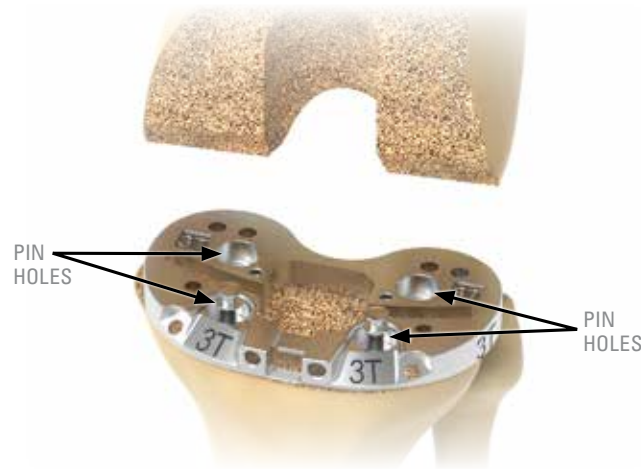

**Figure 36**  
Fixation of Tibial Tray Trial

#### FINAL TIBIAL PREPARATION

When all checks have been completed and the appropriate size and rotation of the tibial components have been determined, the Tibial Baseplate Trial must be pinned in place. Pins may be drilled or driven into the medial and lateral pin holes anteriorly and/or posteriorly on the Tibial Baseplate Trial to provide stability during final tibial preparation. Multiple pinning options are provided on the Tibial Baseplate Trial, including headed or non-headed pins on both anterior and posterior sides (Figure 36).

The **Truliant Syringe Pin Puller** and the **Headed Pin, Short** and **Headed Pin, Long** may be used to pin the Tibial Baseplate Trial in place to provide stability during final tibial preparation.

After tibial trialing, the Syringe Pin Puller can be used to remove the pins from the baseplate trial.

**Note:** When using the Syringe Pin Puller, avoid bending the instrument off-axis during manipulation as such off-axis bending may damage the instrument. The Truliant Syringe Pin Puller and the Headed Pin, Short and Headed Pin, Long are intended to be used together and are not compatible with any other pins or pin pullers. The Headed Pin, Short and Headed Pin, Long are only intended to secure the tibial baseplate trial and are not intended for any other surgical steps.

As an alternative to the Syringe Pin Puller approach, other short-headed screws could be used to fix the Tibial Tray Trial too.

## DETAILED OPERATIVE TECHNIQUE

### FINAL TIBIAL PREPARATION



**Figure 37**  
Drill Pilot Hole on Tibia

Assemble the **Truliant Tibial Pilot Drill Guide** to the Tibial Baseplate Trial. Drill through the Drill Guide with the **14mm Truliant Tibial Pilot Drill** to the depth that matches the selected tibial tray size (*Figure 37*). The drilling depth can be controlled by either reading the indication line on the Drill shaft from the top surface of the Drill Guide, or attaching the **Tibial Pilot Drill Stop** at the desired size (reading from the bottom surface of the Drill Stop).

**Note:** This step is critical to ensure effective tamping and to minimize the risk of tibial fracture.



**Figure 38a**

Assemble the Tamp Head to the Tamp Guide



**Figure 38b**

Set the Desired Size on the Tamp Guide

**Tibial Tamp**

Assemble the **Truliant Tibial Tamp Head** to the **Truliant Tibial Tamp Guide** by pressing the button on the anterior distal end of the Tamp Guide (*Figure 38a*).

Set the size on the Tamp Guide that corresponds to the previously determined tibial tray size by rotating the dial at the proximal end until the desired size is viewed in the window (*Figure 38b*).

## DETAILED OPERATIVE TECHNIQUE

### FINAL TIBIAL PREPARATION



**Figure 39**  
Align Tibial Tamp Guide



**Figure 40a**  
Ensure Complete  
Impaction of Tamp



**Figure 40b**  
Confirm Complete  
Impaction Using the Size  
Marking on the Distal  
Wings of the Tamp Guide

Align the pegs on the bottom of the Tamp Guide with the holes on the Tibial Baseplate Trial and seat the Tamp Guide flush and stable against the Tibial Baseplate Trial (*Figure 39*).

The Tamp Head is driven into the tibia until the impaction plate contacts the dial knob on the Tamp Guide (*Figure 40a*). Complete impaction can also be confirmed using the size markings on the distal wings of the Tamp Guide located on both medial and lateral sides (*Figure 40b*).



**Figure 41**  
Removal of Tamp from Tibia

The Tamp Guide and Tamp Head should be removed from the proximal tibia by gentle retrograde impaction of the impaction plate with a mallet (*Figure 41*).

**Note:** *Be sure to hold the Tamp Guide steady during both impaction and retro-impaction to avoid tilt or lift-off of the Tamp Guide. Off-axis impaction could compromise the integrity of the tibial preparation.*

**Optional instruments available:** After tibial preparation is completed, Truliant Tibial Full Tray Trials can be used to perform trial reduction.

# DETAILED OPERATIVE TECHNIQUE

## PATELLA PREPARATION AND SIZING

### PATELLA IMPLANT OPTIONS

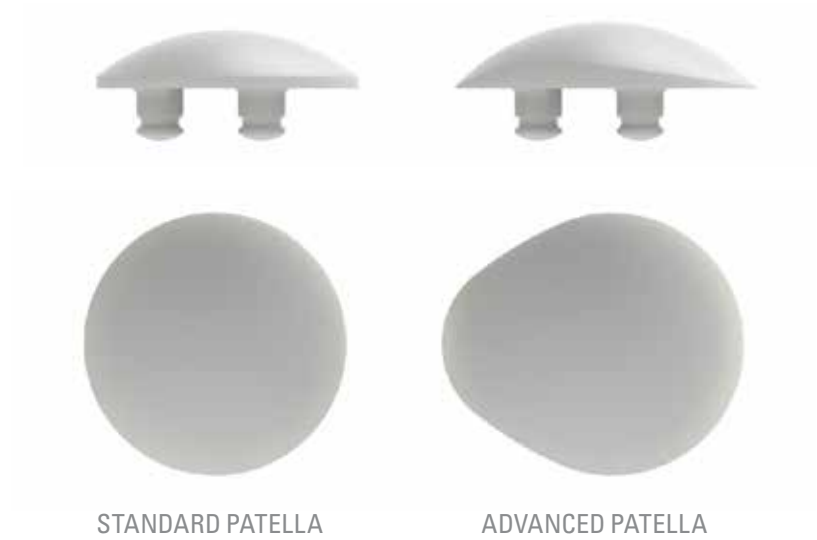

#### STANDARD PATELLA

Diameter (mm)	Thickness (mm)
26	5.1
29	6.1
32	7.2
35	8.5
38	10.0
41	11.0

#### ADVANCED PATELLA\*

Diameter (mm)		Thickness (mm)
A/P	M/L	
26	30	6.1
29	33	7.1
32	37	8.2
35	40	10.0

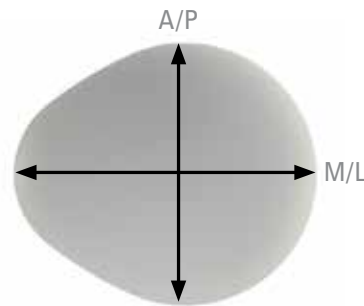

*\*Special Order*

## DETAILED OPERATIVE TECHNIQUE

### PATELLA PREPARATION AND SIZING



**Figure 42a**

Assembly of Patella Drill Guide to Patella Prep Handle for Standard Patella Prep



**Figure 42b**

Assembly of Patella Drill Guide to Patella Prep Handle for Advanced Patella Prep



**Figure 42c**

Assemble the Desired Truliant Patella Drill Guide to the Truliant Spiked Patella Prep Handle

#### PATELLA PREPARATION AND SIZING

For patella resection performed without a patella resection guide ("free hand"), the patella should be stabilized with large towel clips or similar instruments. The articular surface of the patella should be resected with an oscillating saw.

#### Instrument Assembly

When patella resection is complete, final determination of patella size (diameter) and hole preparation should be performed using the appropriate **Drill Guide** assembled to the **Patella Prep Handle** depending on the patella implant to be used (*Figures 42a and 42b*).

**Optional Instrument:** The **Truliant Spiked Patella Prep Handle** has additional spikes on the bottom plate and can be used to provide additional holding stability during patella preparation (*Figure 42c*). \*Special order item.

## DETAILED OPERATIVE TECHNIQUE

### FINAL IMPLANTATION



**Figure 43a**

Drill Holes for Standard Patella Using the Appropriate Drill Guide



**Figure 43b**

Drill Holes for Advanced Patella Using the Appropriate Drill Guide

With the handle completely open, position the Drill Guide on the patella to assess the patellar diameter/bone coverage. The pattern and size of the Drill Guide holes are universal for all three-peg patella components, both the standard patella and the Advanced patella. Clamp the patella and squeeze the handle to secure the position. Holes should be drilled through the Drill Guide (*Figures 43a and 43b*). After the holes are drilled, remove the Prep Handle and Drill Guide from the patella. The appropriate size and style of trial prosthesis should be placed on the patella.

**Note:** *The Advanced Patellar Drill Guide and Trials are special order.*

### FINAL IMPLANTATION

#### Final Bone Preparation

Retractors should be placed to expose the joint. All tissue debris should be removed from resected bone surfaces. The bone trabeculae should be thoroughly cleansed with pulsed lavage.



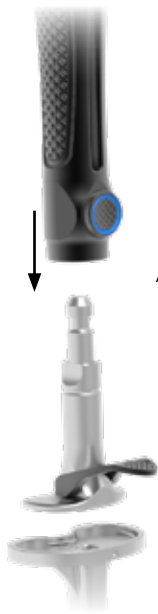

**Figure 44a**  
Assemble Locking Tibial Impactor  
to Modular Handle

**Figure 44b**  
Assemble Locking Tibial Impactor  
to Tibial Component



**Figure 45**  
Place Tibial Component on Resected Tibial Bone

### Implantation of the Tibial Tray Component

Bone cement should be applied to the prosthesis and prepared bone surfaces when the cement has a viscosity low enough to promote good penetration into the trabecular bone. When the **Truliant Fit Tibial Tray** is not used with a stem extension, the poly plug on the distal end of the Fit Tibial Tray should be kept in place to prevent cement penetration.

**Note:** *The Truliant Knee system offers both Cemented and Uncemented tibia baseplates. For additional preparation steps associated with the uncemented components, refer to Appendix D of this surgical technique.*

Apply bone cement to the proximal tibia and the distal surface of the tibial tray component, including the keel, using either a cement gun or by manually pressurizing the cement. Assure

that both the bone and the bone side of the prosthesis are thoroughly coated with cement. When using the Truliant Fit Tray components, ensure that cement is pressed into the cement pockets. Care should be taken to limit the amount of cement placed on the posterior lateral corner of the implant to limit cement cleanup in the posterior capsule. Note that cement should be applied to a dry implant.

Next, assemble the Modular Handle to the **Truliant Locking Tibial Impactor**. Then assemble the Locking Tibial Impactor with the tibial tray component by using the lever mechanism. Using this construct, introduce the tibial tray component into the prepared tibial by applying a constant downward force (Figures 44a, 44b and 45).

**Optional Instrumentation:** *Truliant Tibial Non-Locking Impactor is available.*

## DETAILED OPERATIVE TECHNIQUE

### FINAL IMPLANTATION



**Figure 46**

Position the Femoral Component on the Distal Femur



**Figure 47**

Impact Final Femoral Component

The extraneous cement must be removed from the borders of the tibial component, starting posteriorly and working around to the sides and front. All cement must be removed from the posterior capsular area of the knee.

#### **Implantation of the Femoral Component**

**Note:** For the porous femoral components, application of bone cement is optional. Assemble the porous femoral component to the Locking Femoral Impactor and proceed to positioning the femoral component onto the distal femur.

With the femoral component assembled to the Locking Femoral Impactor, apply bone cement to the bone mating surfaces of the femoral component. Take care to apply only a thin layer of cement on the posterior surface of the prosthesis in order to avoid excessive cement extrusion posteriorly where it could be difficult to remove.

Using the Locking Femoral Impactor, position the femoral component onto the distal femur (*Figure 46*). Slight upward pressure should be applied to the Modular Impactor Handle as the component is being impacted to prevent the femoral component from going into flexion.

Final impaction of the femoral component is performed with the **Truliant Non-locking Femoral Impactor** assembled to the Modular Impactor Handle (*Figure 47*).

Care should be taken to remove all excess bone cement.



**Figure 48**

Clamp Patella Component onto Bone Using the Truliant Patella Prep Handle and Clamp Head

**Implantation of the Patella Component**

Coat the resected patella surface and bone-mating surface of the patella component with cement. Align the pegs of the patella implant with the previously drilled peg holes in the patella bone and press the implant onto the patella.

Assemble the **Truliant Patella Clamp Head** to the Patella Prep Handle. Clamp the patella component onto the patella bone with the Patella Prep Handle and Clamp Head (*Figure 48*), avoiding excessive clamping pressure as it may damage the patella, especially when the bone is soft. Lock the handle using the ratcheting mechanism.

## DETAILED OPERATIVE TECHNIQUE

### FINAL IMPLANTATION



**Figure 49a**

Insert Tibial Implant Adaptor Plate into the Tibial Implant



**Figure 49b**

Insert the Shim/Top Assembly onto Top Surface of the Adaptor Plate

#### **Polymerization of Cement**

The Shim/Top assembly can be used when pressurizing the cement during polymerization. Insert the **Truliant Tibial Implant Adaptor Plate** into the tibial implant (*Figure 49a*).

Then insert the Shim/Top assembly of the selected thickness into the joint space, onto the top surface of the Adaptor Plate (*Figure 49b*). Hold axial pressure across the joint during cement polymerization, avoiding either hyperextension or flexion which may cause the prosthesis to go into either flexion or extension.

This is important in every case, but especially in osteopenic bone. Avoid any movement of the prosthesis until the bone cement has completely polymerized.



**Figure 50**  
Introduce Polyethylene Insert

#### Installation of the Tibial Polyethylene Insert

After polymerization of the cement, introduce the polyethylene insert into the previously implanted tibial tray taking care that the posterior feet of the insert appropriately engage the undercuts of the posterior aspect of the metal tibial tray (*Figure 50*). Ensure that the tibial insert is not rotated relative to the tibial tray and that it is centered. This will allow the posterior feet to line up for proper engagement.

Be sure to check for any soft tissue or bony remnants that could interfere with implant assembly. Continue pushing the polyethylene insert back with two thumbs until the insert is fully engaged and the anterior gap between the tray and the insert is closed.

The **Truliant Tibial Insert Driver** should be used to complete the assembly of the tibial components (*Figure 51*). A mallet should be used for final impaction of the tibial component.

The surgeon should check to be certain that the tibial insert is fully seated in the metal tibial tray.

#### FINAL CHECK AND CLOSURE

Final check includes the following:

1. Removal of any remaining extruded cement
2. Final assessment of:
  - ALIGNMENT, STABILITY, MOTION, PATELLA TRACKING

#### Closure

A standard closure technique preferred by the surgeon may be used.

#### GENERAL NOTES

**Note:** To ensure any instruments continue to perform as intended, visually check and evaluate instruments for any damage or dysfunction prior to surgery. If any breakage or dysfunction is detected, the instrument should be segregated and returned to the manufacturer.

**Note:** Do not impact instruments or areas of instruments that are not intended for impaction, as such excessive load could lead to instrument failure, breakage or reduction of service life. If an instrument is broken during the surgery, any loose components or fragments of the instrument should be carefully detected to confirm there is no debris left in the wound site.



**Figure 51**  
Complete Tibial Component Assembly  
Using Tibial Insert Driver

# APPENDIX

## APPENDIX A

### TRULIANT INTRAMEDULLARY TIBIAL ALIGNMENT GUIDE



**Figure 52a**  
*Adjustable Slope Link*

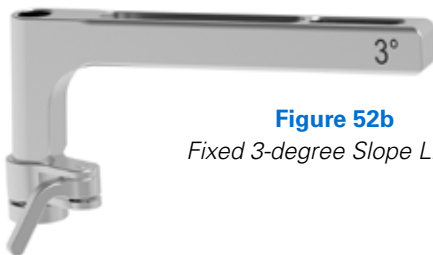

**Figure 52b**  
*Fixed 3-degree Slope Link*

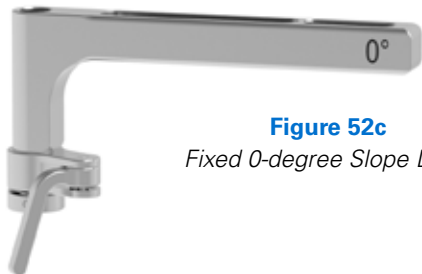

**Figure 52c**  
*Fixed 0-degree Slope Link*



**Figure 52d**  
*Height Adjustment Module*

## INTRODUCTION

The proximal tibial resection can be performed using either the Truliant extra-medullary (EM) tibial preparation method or the Truliant intra-medullary (IM) tibial preparation method. This technique reviews the IM tibial preparation technique.

Follow the Truliant Primary Operative Technique for preparation of the femur.

The Truliant IM Tibial Alignment Guide system consists of two components (*Figure 52*):

1. Slope Link\*

**\*Note:** Three Slope Link options are available according to surgeon preference and technique, including:

- **Adjustable Slope Link (0-10 degrees)** (*Figure 52a*)
- **Fixed 3-degree Slope Link** (*Figure 52b*)
- **Fixed 0-degree Slope Link** (*Figure 52c*)

2. **Height Adjustment Module** (*Figure 52d*)

## APPENDIX A

### TRULIANT INTRAMEDULLARY TIBIAL ALIGNMENT GUIDE

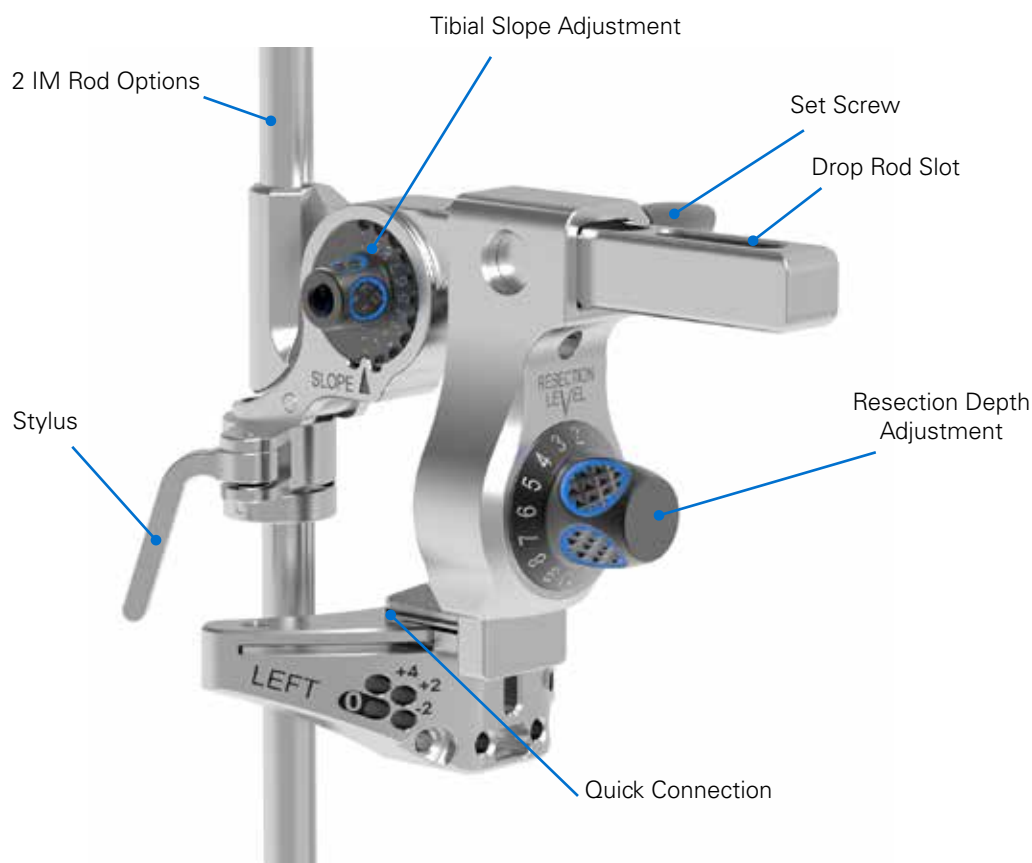

**Figure 53**  
Truliant IM Tibial  
Alignment Guide

The Truliant IM Tibial Alignment Guide system offers the following features (Figure 53):

- A built-in stylus that can sit at the desired location on the tibial plateau for resection depth reference.
- Resection depth adjustment from 0 to 10mm below the tip of the stylus at 1mm increments.
- Tibial slope adjustment from 0 to 10 degrees with one degree increments.

**Note:** The surgeon shall select the proper tibial resection slope based on patient anatomy and surgical technique to ensure optimal surgical outcome.

- Anteroposterior (A/P) adjustment of Tibial Resection Guide position, and a set screw for optional positive lock.

- Quick connection with any style Truliant Tibial Resection Guide\*.
- Drop rod slot available for EM alignment check prior to making tibial cut.
- Compatible with either the standard 9mm IM Rod or a thinner/shorter 6mm IM Rod to fit different patient size and anatomy.

**\*Note:** Only the Truliant Tibial Resection Guide (standard or SM style) of 0-degree slope should be used with the Truliant IM Tibial Alignment Guide system. When Tibial Resection Guide of 3-degree slope is used, the resection depth measurement will be inaccurate due to compound angles.



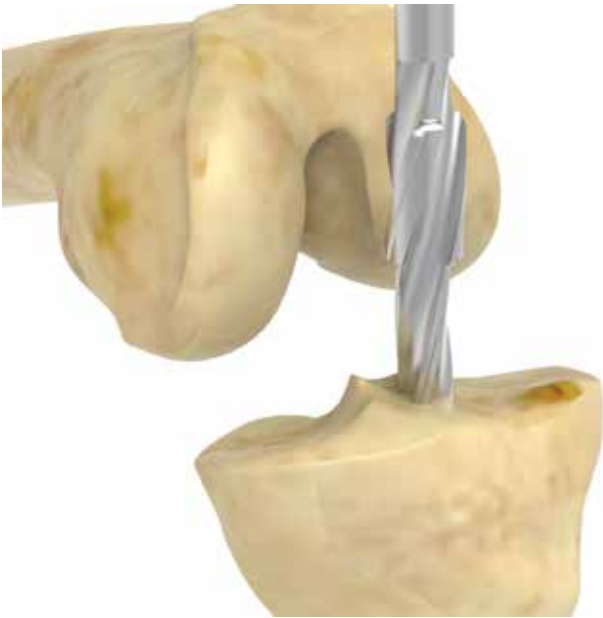

**Figure 54**  
Open Tibial IM Canal



**Figure 55**  
Insert the IM Rod

Identify the entry point to the tibial IM canal on the proximal tibial surface. The recommended anatomical landmark to initiate the perforation of the tibial IM canal is the tibial insertion of the ACL. This point corresponds to a straight proximal extension of the tibial IM canal.

Open the tibial IM canal using the Truliant IM Pilot Drill (*Figure 54*). It is recommended to use a suction cannula to aspirate the contents of the canal.

Assemble the Truliant T-Handle with the selected IM Rod (either the standard 9mm IM Rod or the thinner/shorter 6mm IM Rod based on surgeon preference to best fit the patient size and anatomy). Insert the IM Rod into the tibial IM canal (*Figure 55*). The IM Rod is grooved to allow the endosteal content to be evacuated proximally through the hole, preventing sudden increases in the pressure inside the bone.

## APPENDIX A

### TRULIANT INTRAMEDULLARY TIBIAL ALIGNMENT GUIDE



**Figure 56a**  
Slide Slope Link onto IM  
Rod from Proximal End



**Figure 56b**  
Slide Slope Link onto IM Rod  
from Distal End



**Figure 57**  
Adjust the Slope Angle by  
“Push and Turn”

Assemble the Truliant Tibial Resection Guide with the Height Adjustment Module, and with the Slope Link. The Height Adjustment Module has a flexure feature that adds friction while holding the Tibial Resection Guide.

Attach the Slope Link onto the IM Rod in one of the two ways:

1) Keep the IM Rod in the tibial canal and detach the T-Handle from the IM Rod. Slide the Slope Link onto the IM Rod from the proximal end (*Figure 56a*).

2) Remove the T-Handle and IM Rod from the tibia together. Slide the Slope Link onto the IM Rod from the distal end and place the IM Rod together with the Slope Link back into the tibial canal (*Figure 56b*).

When using the Adjustable Slope Link, the surgeon sets the desired tibial slope angle before attaching the Slope Link onto the IM Rod. The slope angle can also be re-adjusted any time in the workflow prior to pinning the Tibial Resection Guide.

To adjust the slope angle on the Adjustable Slope Link: push the knob down to unlock the angle, turn the knob to the desired angle while holding it down, and release the knob to lock the selected angle (*Figure 57*). This “double-motion” mechanism prevents any unintentional change of the slope angle during the surgery.

As an alternative assembling workflow, the Slope Link alone can be attached onto the IM Rod first; then the Height Adjustment Module and Tibial Resection Guide construct can be slid onto the Slope Link.

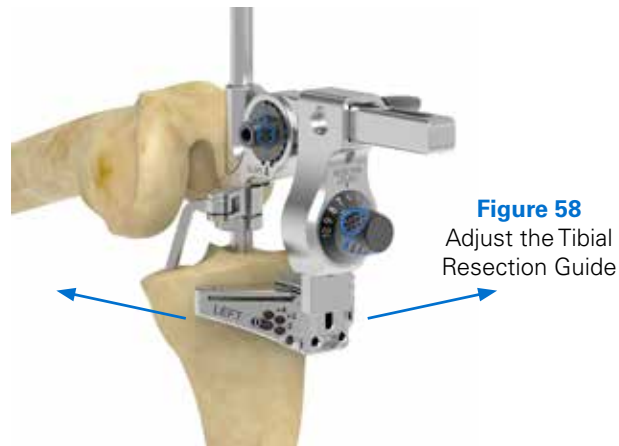

**Figure 58**  
Adjust the Tibial  
Resection Guide

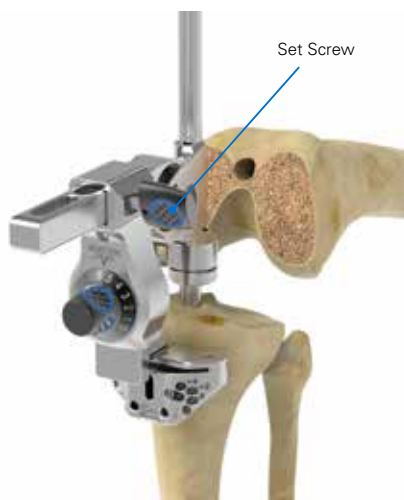

**Figure 59**  
Set Screw to Lock AP Position



**Figure 60**  
Place the Stylus at Desired Location on Tibial Plateau  
and Set Resection Depth

This semi-locking attachment between the Height Adjustment Module and the Tibial Resection Guide also allows mediolateral (M/L) and rotational adjustment of the Tibial Resection Guide before pinning (*Figure 58*).

The A/P position of the Height Adjustment Module can be continuously adjusted to optimize the position of the Tibial Resection Guide relative to the bone.

A set screw can be used to optionally lock the A/P position if preferred (*Figure 59*).

Place the stylus of the Slope Link at the desired location on the tibial plateau. If needed, remove extra bone near the tibial spine using a rongeur to ensure the stylus has enough clearance to touch the desired location on the tibial plateau. Adjust the knob on the Height Adjustment Module to set the desired resection depth. The reading of "Resection Level" indicates how many millimeters the resection plane is below the tip of the stylus (*Figure 60*).

## APPENDIX A

### TRULIANT INTRAMEDULLARY TIBIAL ALIGNMENT GUIDE



**Figure 61**  
Using Drop Rod to Check Alignment

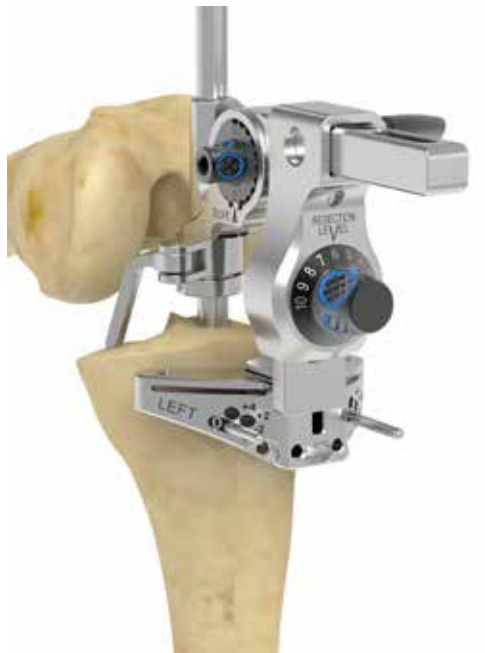

**Figure 62**  
Pin Resection Guide

A **Drop Rod** and **Extension** can also be placed through the slot on the Slope Link to check alignment prior to making the tibial cut (*Figure 61*).

Adjustments to the tibial resection guide's M/L position and rotation, resection depth, and slope angle (when using the Adjustable Slope Link) can be made before pinning the Tibial Resection Guide onto the bone. The Truliant Joint Line Predictor may be used to evaluate the tibial resection level and slope through the cutting slot of the Tibial Resection Guide (*Figure 62*). Once the desired location is set, proceed to pin the Resection Guide into the tibia (*Figure 62*).

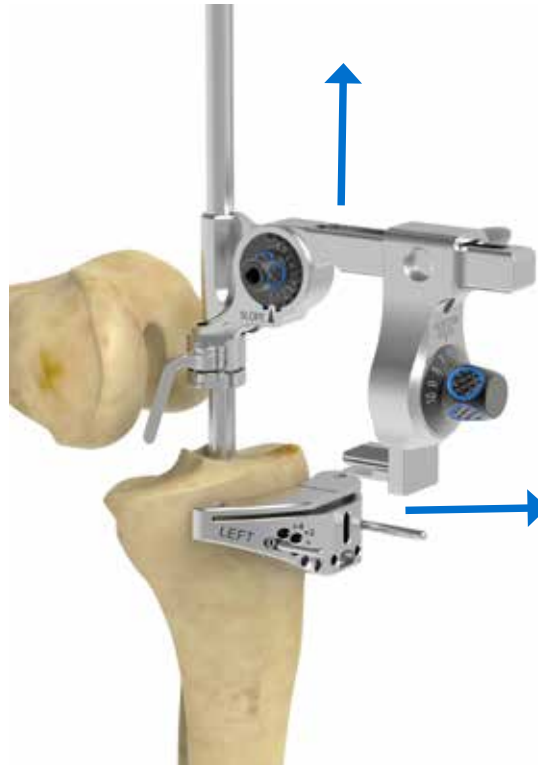

Figure 63

Remove Instrument Construct

After pinned through the “0” holes, the Tibial Resection Guide may be adjusted proximally or distally in 2mm increments by shifting the Tibial Resection Guide onto either the -2mm, +2mm, or +4mm shift holes. If the resection is performed on the proximal flat surface of the Tibial Resection Guide, it resects 4mm less bone. Cross pin holes are also available on the Tibial Resection Guide for additional stability during bone resection. After pinning the Tibial Resection Guide, remove all IM Tibial Alignment Guide instruments, and only leave the Tibial Resection Guide on the bone (Figure 63). To remove the instrument construct, unlock the set screw between the Height Adjustment Module and the Slope Link and gently pull the Height Adjustment Module anteriorly to detach it from the Tibial Resection Guide. Using both hands to hold the entire construct including the IM Rod, pull the entire construct upward to remove from the bone (Figure 63).

**Note:** When detaching the Height Adjustment Module from the Tibial Resection Guide, it's recommended that the user uses one hand to secure the Tibial Resection Guide in place, while using the other hand to pull the Height Adjustment Module anteriorly, in order not to compromise the fixation of the Tibial Resection Guide.

Proceed to cut the proximal tibia through the Tibial Resection Guide.

Follow the remaining steps of the Truliant Primary Operative Technique to complete the surgery.

## APPENDIX B

### TRULIANT RE-CUT REFERENCERS



**Figure 64**

Truliant 2° Varus/Valgus Re-Cut Referencer



**Figure 65**

Assembly of the Truliant 2° Varus/Valgus Re-Cut Referencer to the Truliant Tibial Resection Guide

#### TRULIANT 2° VARUS/VALGUS RE-CUT REFERENCER

The **Truliant 2° Varus/Valgus Re-Cut Referencer** will reposition the Tibial Resection Guide 2 degrees from the existing proximal tibial resection. Depending on the orientation of the referencer, the Tibial Resection Guide will be positioned 2 degrees varus or 2 degrees valgus from the existing resection (*Figure 64*).

Assemble the 2° Varus/Valgus Re-Cut Referencer to the Tibial Resection Guide (*Figure 65*).



**Figure 66**  
Placement of 2° Varus/Valgus Re-Cut Referencer  
Assembly on the Proximal Tibia

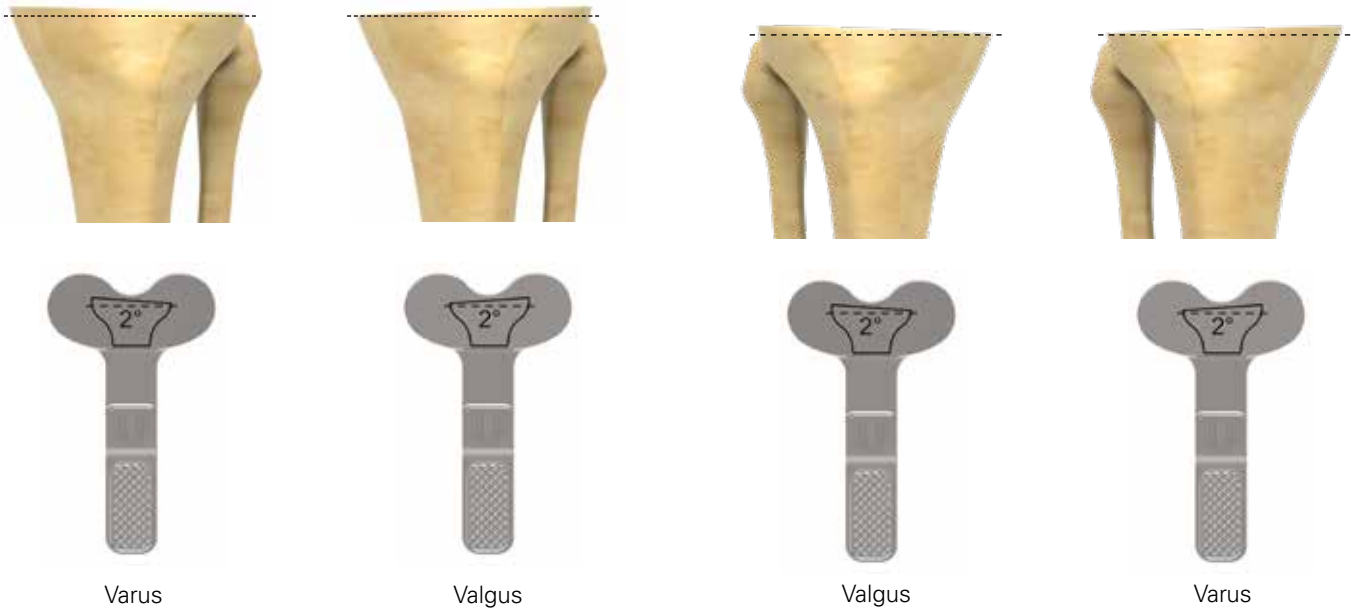

**Figure 67a**

Orientation of Varus/Valgus Re-Cut Referencer for a Left Knee

**Figure 67b**

Orientation of Varus/Valgus Re-Cut Referencer for a Right Knee

Place the 2° Varus/Valgus Re-Cut Referencer assembly on the cut surface of the proximal tibia in the correct orientation to achieve the desired tibial resection (Figures 66, 67a and 67b). Pin the Tibial Resection Guide in place using the zero holes and proceed to make the proximal tibial resection.

## APPENDIX B

### TRULIANT RE-CUT REFERENCERS

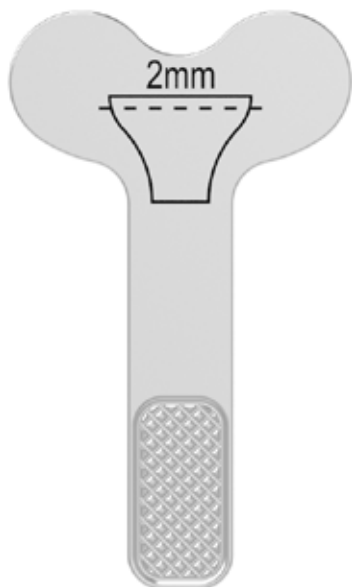

**Figure 68**

Truliant 2mm Re-Cut Referencer



**Figure 69**

Assemble the Truliant 2mm Re-Cut Referencer to the Truliant Tibial Resection Guide

---

#### TRULIANT 2mm RE-CUT REFERENCER

After completion of the proximal tibial resection, the **Truliant 2mm Re-Cut Referencer** (*Figure 68*) can be used to resect an additional 2mm of bone.

Assemble the 2mm Re-Cut Referencer to the Truliant Tibial Resection Guide (*Figure 69*).





**Figure 70**

Placement of 2mm Re-Cut Referencer Assembly on the Proximal Tibia

---

Place the 2mm Re-Cut Referencer assembly on the cut surface of the proximal tibia to achieve the desired tibial resection (*Figure 70*). Pin the Tibial Resection Guide in place using the zero holes and proceed to make the proximal tibial resection.

## APPENDIX C

### TRULIANT LIGAMENT BALANCING SYSTEM (LBS-3)

#### SURGICAL TECHNIQUE

Follow the Truliant Operative Technique for resection of the distal femur and proximal tibia. It is important to ensure a precise tibial cut, as a varus or valgus tibial cut will affect the rotation of the femoral positioning in the LBS-3 technique.

#### EXTENSION BALANCING

Position the **LBS-3 Tensor** between the resected femur and tibia in extension (*Figure 71*). The bottom plates of the Tensor are resting on the resected proximal tibia, and the top plates of the Tensor are touching the resected distal femur. Turn the Tensor handle until the ligaments are appropriately tensioned. It is important to recognize the Tensor's three marks representing three levels of force applied by the tensor (*Figure 72, blue arrow*). The middle level is recommended although the surgeon can choose to use higher or lower force based on his/her preference and patient condition (*Figure 72, blue arrow*). It is not recommended to use a force outside of the high and low marks and it is important to use a consistent force with the tensor throughout the procedure. The extension gap measurement (*Figure 72, red arrow*) can be a combined result of both the force exerted on the tensor and the anatomy and soft tissue properties of the joint. Evaluation of the varus/valgus stability of the joint under tension can be completed prior to selecting a final gap measurement. The extension gap (mm) measurement and poly thickness (mm) measurement (*Figure 72, green arrow*) can be read directly from the Tensor.

**Note:** The extension gap reading is the total joint space between the resected tibia and femur (thus the combined thickness of femoral and tibial implants), while the poly thickness reading is the tibial implant thickness only.

The medial and lateral extension gap measurements are independent; however, an ideal gap of a rectangular joint space should result in close measurements on both sides. Adjustments may be made to the soft tissue or bone resections if the gap is not rectangular.



**Figure 71**  
Place Tensor in Extension

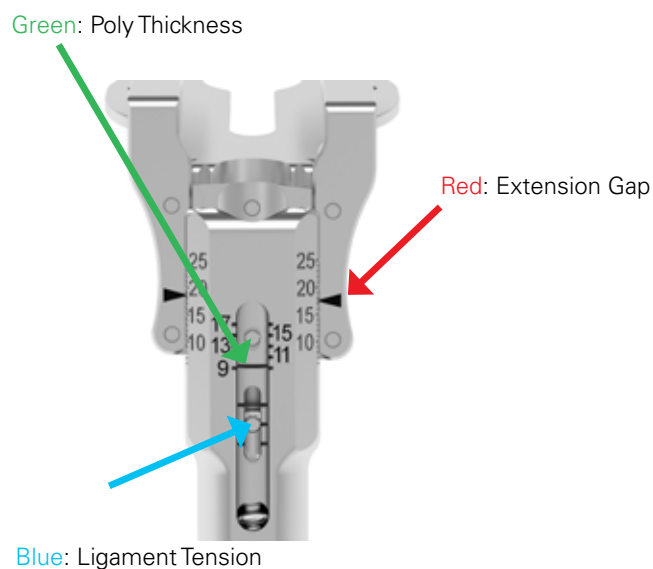

**Figure 72**  
Tensor Markings

**Figure 73a**

Assemble the LBS-3 Instruments

**Figure 73b**

Place LBS-3 Instruments at Knee Flexion

The poly thickness measurement is an average of the medial and lateral extension gap measurements. If the poly thickness measurement is less than 9mm, the extension gap can't accommodate the minimum thickness of implant construct thus additional bone resection might be needed.

Once a rectangular joint space with a minimum 9mm height is achieved at extension, remove the Tensor from the joint.

#### **FLEXION BALANCING AND SIZING**

Assemble the **Truliant LBS-3 Adaptor Anterior Body**, **Posterior Body** and **Stylus** together, and slide the **LBS-3 Adaptor** onto the LBS-3 Tensor (*Figure 73a*).

Flex the knee at 90 degrees of flexion, and place the instruments into the joint (*Figure 73b*):

- The bottom plates of the Tensor are resting on the resected proximal tibia;
- The top plates of the Tensor are touching the posterior condyles of the femur;
- The Posterior Body of the Adaptor is flush against the resected distal femur surface;
- The Anterior Body of the Adaptor slides open to allow the Stylus to rest on the anterior cortex of the distal femur.

Keep the knee at 90 degrees of flexion and verify the Posterior Body of the Adaptor is flush against the resected distal surface of the femur (*Figure 73b*). Tense the joint open by turning the Tensor handle to the previously identified tension mark in extension.

## APPENDIX C

### TRULIANT LIGAMENT BALANCING SYSTEM (LBS-3)

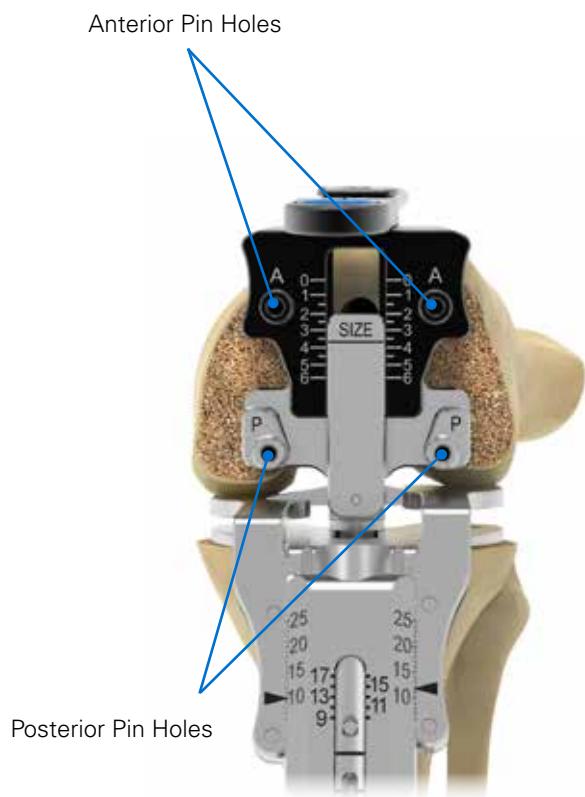

**Figure 74**

Anterior and Posterior Pin Holes

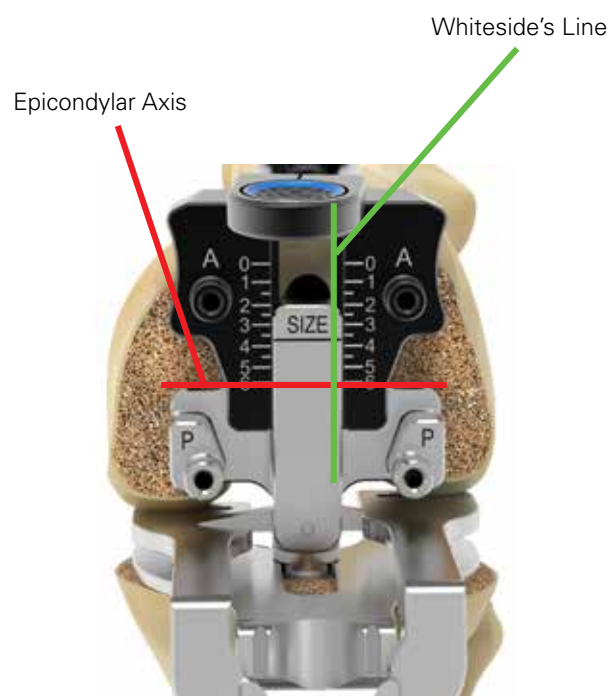

**Figure 75**

Use Anatomical Landmarks as Reference

The rotation of the femur under tension is a result of the properties of the ligaments and soft tissue around the knee and differs on each patient. Therefore, the LBS-3 technique offers a personalized ligament-balancing technique that defines the femoral implant position according to the biomechanical response of the patient's soft tissue.

With the LBS-3 Adaptor instruments, the two pairs of pin holes (one pair on Anterior Body and one pair on Posterior Body) are parallel to the proximal tibial cut and will be used to position the Femoral Finishing Guide (*Figure 74*). As a result, the Femoral Finishing Guide will create a rectangular space for the flexion gap, considering the patient's individual soft tissue properties.

Before proceeding to the next steps, anatomical landmarks can be used to verify and fine-tune the femoral rotation if desired (i.e., the sliding bar between the Anterior Body and Posterior Body should be parallel with Whiteside's line, and the pin hole pairs should be parallel to the epicondylar axis of the femur) (*Figure 75*).



**Figure 76a**  
LBS-3 as Femoral Sizer



**Figure 76b**  
Setting Stylus to  
Match Size



**Figure 77**  
Reading Femoral Size

In addition to setting femoral rotation, the LBS-3 Adaptor also serves as a sizer for the femur. Slide the Anterior Body and place the tip of the Stylus underneath the quadriceps and into the suprapatellar pouch. Palpate the position of the Stylus tip, trying to make it rest in the midportion of the femoral metaphysis (*Figures 76a and 76b*). The size marking between Anterior Body and Posterior Body reads the size for the femoral implant (*Figure 77*). Keeping the Stylus length matched with the Anterior Body size reading will increase the sizing accuracy (*Figure 76b*).

The Truliant LBS-3 instruments can support either anterior referencing (AR) or posterior referencing (PR) technique.

- The AR technique prioritizes implant position on the anterior aspect of the femur when the bone is measured between sizes. The advantage is that it minimizes notching risk, while

the disadvantage is that the posterior joint line could change slightly in between-size scenarios.

- The PR technique prioritizes implant position on the posterior aspect when the bone is measured between sizes. The advantage is that it maintains a constant posterior joint line, while the disadvantage is the increased notching risk in between-size scenarios.

With the Truliant implant system having a small between-size jump in the anteroposterior (AP) direction (approximately 2 mm), the practical difference between AR and PR techniques is minimal at approximately 1 mm. In addition, the Truliant Femoral Finishing Guide features AP shifting holes that allows additional fine-tuning of implant position. Because of this ability to fine-tune the flexion gap later in the surgical flow and being less sensitive to errors, the AR technique is usually recommended over the PR technique when using the Truliant LBS-3 system.

## APPENDIX C

### TRULIANT LIGAMENT BALANCING SYSTEM (LBS-3)



**Figure 78**

Ensure Posterior Body is Flush with Distal Femur during Pinning



**Figure 79a**  
Anterior Referencing Technique using Anterior Pins



**Figure 79b**  
Posterior Referencing Technique using Posterior Pins

Ensure the back surface of the Posterior Body is sitting flush with the distal femur cut (this requires the knee being flexed at 90 degrees) (Figure 78). Insert two headless pins into the pin hole on the Anterior Body (marked with letter "A") if the surgeon uses AR technique (Figure 79a), or the pin holes on the Posterior Body (marked with letter "P") if the surgeon uses PR technique (Figure 79b). These alignment pins will later be used to position the Femoral Finishing Guide.

**Note:** It's critical in the PR technique to ensure the Posterior Body is flush with the distal femur when placing the pins. If the Posterior Body isn't flush, the position and/or orientation of the pins could be off which may increase risk of incorrect sizing and anterior notching during femoral finishing.

The LBS-3 Tensor and Adaptor instruments can now be removed from the joint, leaving the two alignment pins in place. The pins lock the rotation of the Femoral Finishing Guide and then the femoral implant.



**Figure 80**

Place Pins with Only Posterior Body

**Figure 81**

Temporary Pinning Posterior Body and Easing Anterior Body for Sizing

Some technique variations could be used based on the user's preference:

- When surgeons use a PR technique, they could assemble the Posterior Body of the Adaptor to the LBS-3 Tensor first, without assembling the Anterior Body and the Stylus at the same time. Follow all other steps and place the alignment pins into the "P" holes while ensuring the back surface of the Posterior Body is flush with the distal femur cut (*Figure 80*). After the Posterior Body is fixed with the pins, the Anterior Body and Stylus can then be assembled to do the femoral sizing.
- When surgeons use a AR technique they may opt to put two provisional pins (can be headed pins) in the "P" holes to temporarily secure the Posterior Body and ease the manipulation of the Anterior Body and Stylus during sizing (*Figure 81*). These two extra pins need to be removed before removing the LBS-3 Tensor and Adaptor instruments from the joint.

## APPENDIX D

### TRULIANT POROUS TIBIA



**Figure 82a**  
Insert Tibial Pilot Drill into Drill Guide



**Figure 82b**  
Prepare Peg Pilot Holes

Insert the **Pilot Drill** into the **Pilot Drill Guide**, positioning the tip of the drill at the center of the guide. Ensure the drill tip is touching bone inside the drill guide before applying power. Drill until the drill stop engages the proximal end of the drill guide (*Figure 82a*). Remove the drill.

**Note:** It may be necessary to stabilize the Pilot Drill Guide by hand during drilling.

With the Pilot Drill Guide still in place, use the **Truliant Porous Tibia Peg Drill** and drill the four peg pilot holes. Drill each hole until the collar on the drill engages the drill guide (*Figure 82b*).

**Note:** It may be necessary to stabilize the Pilot Drill Guide by hand during drilling.

**After drilling, remove the Pilot Drill Guide.**





**Figure 83**  
Assemble Tibial Tamp Head to Tamp Guide



**Figure 84**  
Rotate Knob Until the Appropriate Size is in View

Assemble the **Truliant Porous Tibial Tamp Head** to the **Truliant Tibial Tamp Guide** by pressing the button on the anterior distal end of the Tibial Tamp Guide and sliding the Porous Tibial Tamp Head into the guide connection feature (*Figure 83*).

Select the size corresponding to the selected **Porous Tibial Tray Trial** on the Tibial Tamp Guide by rotating the proximal knob until the appropriate size is viewed in the window (*Figure 84*).

## APPENDIX D

### TRULIANT POROUS TIBIA



**Figure 85**  
Place Truliant Tamp Guide

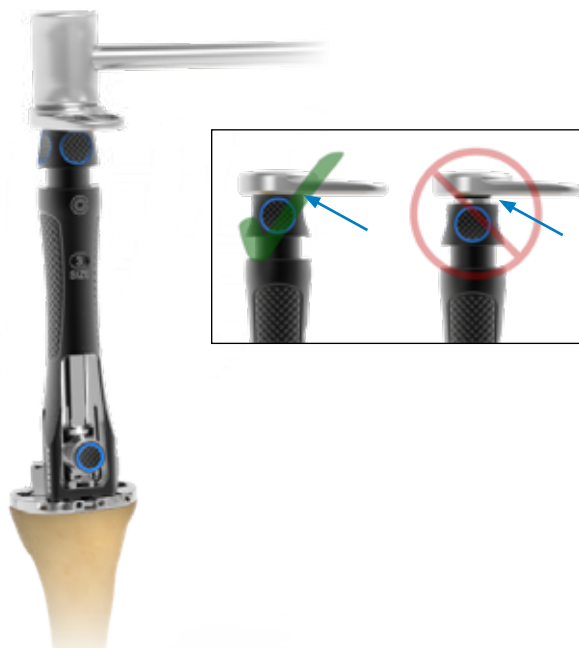

**Figure 86**  
Impact Tray Tamp Until Flush with Top of Handle

Position the Tibial Tamp Guide Assembly by inserting the anterior distal pegs of the guide into the anterior counter bores found on the Porous Tibial Tray Trial and seat the Tibial Tamp Guide flush and stable against the tray by engaging the posterior pegs (Figure 85).

The Tamp Head is driven by striking the proximal strike plate until the impactation plate contacts the adjustment knob (Figure 86).

**Note:** Be sure to hold the Tibial Tamp Guide steady during impaction to avoid tilt or lift-off. Ensure the Tibial Tray Trial is flush with the proximal tibia throughout impaction. If any prominent bone is present that prevents the Tibial Tray Trial from laying flush on the bone, then it may be necessary to use an osteotome to prepare the affected area prior to final tibial tamp head seating.

After the Tamp Head is fully seated, hit the underside of the strike plate on the Tamp Guide to disengage the Tamp Head from the proximal tibia.

Remove the Tibial Tamp Guide, the Tibial Tray Trial and pins.



**Figure 87**  
Assemble Impactor Plate and Component

## FINAL IMPLANTATION

### CEMENTLESS IMPLANTATION

**Note:** When using cementless components, it is critical to ensure that the bone resection surfaces are flat and free of debris, fragments or unintended prominences.

**Note:** A slurry of morselized autograft bone (bone resection remnants) may be placed on the proximal tibia prior to implantation to fill small cancellous cavities.

**Caution:** It is important to properly handle the Porous Tibial Tray component. Do not touch the porous surface of the implant. The rough porous surface of the tibial component can ensnare a glove, towel or lap sponge. Keep the implant in the sterile packaging until it is ready to be implanted.

Assemble the **Truliant Universal Modular Handle** to the **Truliant Locking Tibial Impactor**. Attach the Porous Tibial Tray to the handle and introduce the Porous Tibial Tray into the prepared tibia by applying a constant downward force (Figure 87).

## APPENDIX D

### TRULIANT POROUS TIBIA



**Figure 88**

Impact Tibial Component Until Fully Seated

Verify the proper rotational orientation in the transverse plane using the keel and pegs and strike the proximal surface of the handle with a mallet, until the Porous Tibial Tray is fully seated. (Figure 88). Check to ensure that Porous Tibial Tray is in full contact with the tibial surface around the **entire** periphery of the tibial tray.

If removal of the Porous Tibial Tray Component is necessary during surgery, reattach the Locking Tibial Impactor to the tray. Then pull the Porous Tibial Tray out.

**Note:** Should removal of the Porous Tibial Tray become necessary, it is not recommended to re-implant the tray as the prepared surface could become damaged during removal. As such, it is recommended to switch to a Truliant Cemented Implant (reference the Truliant Primary Operative Technique).



**Figure 89a**  
Remove Screw Seals



**Figure 89b**  
Prepare Bone Screw Pilot Holes

## OPTIONAL FIXATION METHODS

If additional tibial tray stability is desired, proceed to the following sections for optional screw fixation or cemented component preparation and implantation.

### OPTIONAL SCREW FIXATION THROUGH POROUS TIBIAL TRAY COMPONENT

If supplemental fixation is desired, two bone screws can be placed through the Porous Tibial Tray Component. Carefully unthread the two screw seals from the Porous Tibial Tray Component with a 3.5mm hex-driver (*Figure 89a*). The screw seals can be discarded.

**Note:** Screw seal removal should be performed prior to implantation if the surgeon has already decided to use supplemental screw fixation. If it is decided that additional

fixation is necessary after implanting care must be taken to apply a counter torque to the tray during screw seal removal so as to avoid damaging the fit with the bone.

Place the **Truliant Bone Screw Drill Guide** into one of the tibial tray bone screw holes. The Bone Screw Drill Guide is seated properly when its head nests in the bone screw hole counterbore of the Porous Tibial Tray (*Figure 89b*). The cone-shaped hole in the drill guide allows screws to be positioned at a maximum angle of 12° from normal in any direction. The **Truliant Porous Tibia Peg Drill** bit is used to prepare the holes for the bone screws through the Bone Screw Drill Guide. Drill each hole to the desired position and angle.

**Caution:** Care should be taken to ensure the Collar Drill does not perforate the tibial cortex.

## APPENDIX D

### TRULIANT POROUS TIBIA



**Figure 90**  
Seat Bone Screws



**Figure 91a**  
Press Cement Into Prosthesis

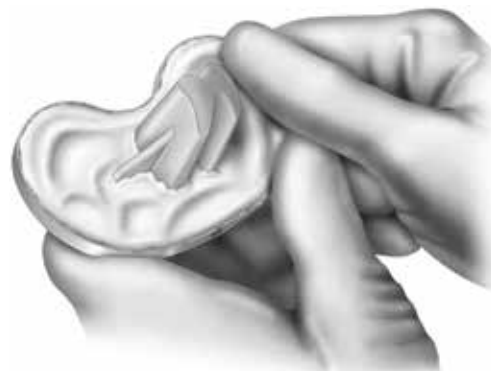

**Figure 91b**  
Coat Tray Thoroughly with Cement

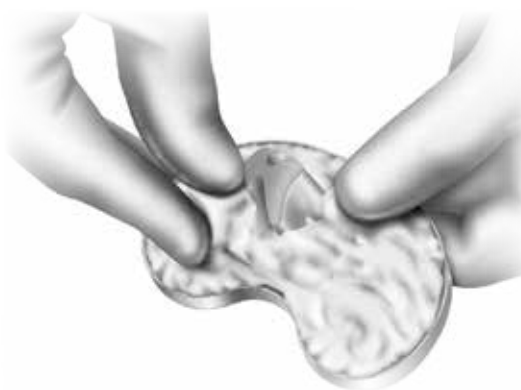

**Figure 91c**  
Coat Keel Thoroughly with Cement

Use the 3.5mm Hex Driver to seat Alteon®, 6.5mm bone screws into each of the screw holes in the Porous Tibial Tray (Figure 90).

**Caution:** Do not drive screws with power, use provided instruments.

## CEMENTED IMPLANTATION

*The Porous Truliant Tibia is also indicated for cemented use.*

### TIBIAL PREPARATION TO ACCEPT CEMENT COMPONENT

Bone cement should be applied to the prosthesis and prepared bone surfaces when the cement has a viscosity low enough to facilitate good penetration into the trabecular bone.

Bone cement should be applied to the proximal tibia and the distal surface of the tibial tray component, including the stem, using either a cement gun or by manually pressurizing the cement (Figures 91a - 91c).



**Figure 92**  
Impact Tibial Component Until Fully Seated

---

Next, assemble the Truliant Tibial Locking Impactor to the Truliant Universal Modular Handle. Attach the Porous Tibial Tray to the handle and introduce the Porous Tibial Tray into the prepared tibia by applying a constant downward force until fully seated.

Impact the Impactor assembly to fully seat the tibial component (*Figure 92*).

Remove all of the extraneous cement from the borders of the tibial component, starting posteriorly and working around to the sides and front.

# **INSTRUMENT LISTING**



## INSTRUMENT LISTING

**CATALOG NUMBER    PART DESCRIPTION**

02-029-11-1000      Truliant Femoral Intra-medullary Pilot Drill



02-029-21-3300      Truliant Intra-medullary Rod 6mm

02-029-11-1100      Truliant Intra-medullary Rod 9mm



02-029-11-1300      Truliant Modular T-Handle  
02-029-11-1200



02-029-11-2100      Truliant Distal Femoral Link



02-029-11-2000      Truliant Distal Femoral Alignment Guide



02-029-11-8000      Truliant Distal Femoral Resection Guide



02-029-21-1100      Truliant Extra-Medullary Alignment Upright



02-029-21-1000      Truliant Ankle Clamp



02-029-21-8010      Truliant Tibial Resection Guide, Left  
02-029-21-8020      Truliant Tibial Resection Guide, Right



02-029-21-8110      Truliant Tibial Resection Guide (SM), Left  
02-029-21-8120      Truliant Tibial Resection Guide (SM), MIS, Right  
02-029-21-8310      Truliant Tibial Resection Guide (SM), 3°, Left  
02-029-21-8320      Truliant Tibial Resection Guide (SM), 3°, Right



## INSTRUMENT LISTING

### CATALOG NUMBER PART DESCRIPTION

02-029-21-4000 Truliant Adjustable Tibial Stylus



02-029-29-1100 Truliant Alignment Rod Handle



02-029-29-2000 Truliant Extra-medullary Alignment Rod/Coupler



02-029-29-2100 Truliant Extra-medullary Alignment Rod Extension



02-029-90-6000 Truliant Cut Line Predictor



02-029-90-2010 Truliant Spacer Block, 9 and 11mm

02-029-90-2020 Truliant Spacer Block, 13 and 15mm

02-029-90-2030 Truliant Spacer Block, 17 and 19mm

02-029-90-2040 Truliant Spacer Block, 5 and 7mm



02-029-90-2100 Truliant Spacer Block Shim, 1mm

02-029-90-2120 Truliant Spacer Block Shim, 4mm

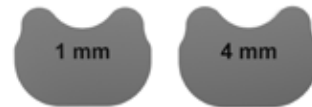

02-029-21-3000 IM Tibial Guide, Adjustable Slope Link



02-029-21-3100 IM Tibial Guide, 0-degree Slope Link



02-029-21-3130 IM Tibial Guide, 3-degree Slope Link



**CATALOG NUMBER    PART DESCRIPTION**

02-029-21-3200      IM Tibial Guide, Height Adjustment Module



02-029-12-1200  
02-029-12-1000      Truliant Femoral A/P Sizer



02-029-13-8000\*      Truliant Femoral Finishing Guide, Size 0  
02-029-13-8010      Truliant Femoral Finishing Guide, Size 1  
02-029-13-8015      Truliant Femoral Finishing Guide, Size 1.5  
02-029-13-8020      Truliant Femoral Finishing Guide, Size 2  
02-029-13-8025      Truliant Femoral Finishing Guide, Size 2.5  
02-029-13-8030      Truliant Femoral Finishing Guide, Size 3  
02-029-13-8035      Truliant Femoral Finishing Guide, Size 3.5  
02-029-13-8040      Truliant Femoral Finishing Guide, Size 4  
02-029-13-8045      Truliant Femoral Finishing Guide, Size 4.5  
02-029-13-8050      Truliant Femoral Finishing Guide, Size 5  
02-029-13-8060\*      Truliant Femoral Finishing Guide, Size 6

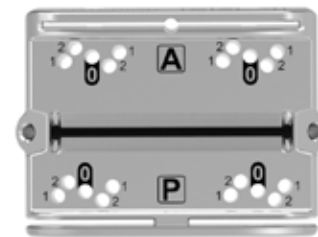

02-029-15-1000\*      Truliant Femoral Trial, Size 0  
02-029-15-1010      Truliant Femoral Trial, Size 1  
02-029-15-1015      Truliant Femoral Trial, Size 1.5  
02-029-15-1020      Truliant Femoral Trial, Size 2  
02-029-15-1025      Truliant Femoral Trial, Size 2.5  
02-029-15-1030      Truliant Femoral Trial, Size 3  
02-029-15-1035      Truliant Femoral Trial, Size 3.5  
02-029-15-1040      Truliant Femoral Trial, Size 4  
02-029-15-1045      Truliant Femoral Trial, Size 4.5  
02-029-15-1050      Truliant Femoral Trial, Size 5  
02-029-15-1060\*      Truliant Femoral Trial, Size 6



02-029-90-1000      Truliant Universal Modular Handle



02-029-19-1000      Truliant Femoral Impactor, Locking



## INSTRUMENT LISTING

### CATALOG NUMBER PART DESCRIPTION

02-029-19-1100 Truliant Femoral Impactor, Non-locking



02-029-15-2000\* Truliant PS Notch Guide, Size 0  
 02-029-15-2010 Truliant PS Notch Guide, Size 1  
 02-029-15-2015 Truliant PS Notch Guide, Size 1.5  
 02-029-15-2020 Truliant PS Notch Guide, Size 2  
 02-029-15-2025 Truliant PS Notch Guide, Size 2.5  
 02-029-15-2030 Truliant PS Notch Guide, Size 3  
 02-029-15-2035 Truliant PS Notch Guide, Size 3.5  
 02-029-15-2040 Truliant PS Notch Guide, Size 4  
 02-029-15-2045 Truliant PS Notch Guide, Size 4.5  
 02-029-15-2050 Truliant PS Notch Guide, Size 5  
 02-029-15-2060\* Truliant PS Notch Guide, Size 6



02-029-15-3000\* Truliant PS Notch Cutter, Size 0  
 02-029-15-3010 Truliant PS Notch Cutter, Size 1  
 02-029-15-3015 Truliant PS Notch Cutter, Size 1.5  
 02-029-15-3020 Truliant PS Notch Cutter, Size 2  
 02-029-15-3025 Truliant PS Notch Cutter, Size 2.5  
 02-029-15-3030 Truliant PS Notch Cutter, Size 3  
 02-029-15-3035 Truliant PS Notch Cutter, Size 3.5  
 02-029-15-3040 Truliant PS Notch Cutter, Size 4  
 02-029-15-3045 Truliant PS Notch Cutter, Size 4.5  
 02-029-15-3050 Truliant PS Notch Cutter, Size 5  
 02-029-15-3060\* Truliant PS Notch Cutter, Size 6



02-029-15-4000\* Truliant PS Cam Trial, Size 0  
 02-029-15-4010 Truliant PS Cam Trial, Size 1  
 02-029-15-4015 Truliant PS Cam Trial, Size 1.5  
 02-029-15-4020 Truliant PS Cam Trial, Size 2  
 02-029-15-4025 Truliant PS Cam Trial, Size 2.5  
 02-029-15-4030 Truliant PS Cam Trial, Size 3  
 02-029-15-4035 Truliant PS Cam Trial, Size 3.5  
 02-029-15-4040 Truliant PS Cam Trial, Size 4  
 02-029-15-4045 Truliant PS Cam Trial, Size 4.5  
 02-029-15-4050 Truliant PS Cam Trial, Size 5  
 02-029-15-4060\* Truliant PS Cam Trial, Size 6



CATALOG NUMBER	PART DESCRIPTION
02-029-25-1000	Truliant Baseplate Trial, Size 0T
02-029-25-1005	Truliant Baseplate Trial, Size 0.5T
02-029-25-1010	Truliant Baseplate Trial, Size 1T
02-029-25-1015	Truliant Baseplate Trial, Size 1.5T
02-029-25-1020	Truliant Baseplate Trial, Size 2T
02-029-25-1025	Truliant Baseplate Trial, Size 2.5T
02-029-25-1030	Truliant Baseplate Trial, Size 3T
02-029-25-1035	Truliant Baseplate Trial, Size 3.5T
02-029-25-1040	Truliant Baseplate Trial, Size 4T
02-029-25-1045	Truliant Baseplate Trial, Size 4.5T
02-029-25-1050	Truliant Baseplate Trial, Size 5T
02-029-25-1055	Truliant Baseplate Trial, Size 5.5T
02-029-25-1060	Truliant Baseplate Trial, Size 6T
02-029-25-5000	Truliant Tibial Full Tray Trial, Size 0T
02-029-25-5005	Truliant Tibial Full Tray Trial, Size 0.5T
02-029-25-5010	Truliant Tibial Full Tray Trial, Size 1T
02-029-25-5015	Truliant Tibial Full Tray Trial, Size 1.5T
02-029-25-5020	Truliant Tibial Full Tray Trial, Size 2T
02-029-25-5025	Truliant Tibial Full Tray Trial, Size 2.5T
02-029-25-5030	Truliant Tibial Full Tray Trial, Size 3T
02-029-25-5035	Truliant Tibial Full Tray Trial, Size 3.5T
02-029-25-5040	Truliant Tibial Full Tray Trial, Size 4T
02-029-25-5045	Truliant Tibial Full Tray Trial, Size 4.5T
02-029-25-5050	Truliant Tibial Full Tray Trial, Size 5T
02-029-25-5055	Truliant Tibial Full Tray Trial, Size 5.5T
02-029-25-5060	Truliant Tibial Full Tray Trial, Size 6T



## INSTRUMENT LISTING

### CATALOG NUMBER PART DESCRIPTION

02-029-25-2609*	Truliant Tibial Insert Trial Shim, Size 0, 9mm
02-029-25-2610*	Truliant Tibial Insert Trial Shim, Size 0, 10mm
02-029-25-2611*	Truliant Tibial Insert Trial Shim, Size 0, 11mm
02-029-25-2612*	Truliant Tibial Insert Trial Shim, Size 0, 12mm
02-029-25-2613*	Truliant Tibial Insert Trial Shim, Size 0, 13mm
02-029-25-2615*	Truliant Tibial Insert Trial Shim, Size 0, 15mm
02-029-25-2617*	Truliant Tibial Insert Trial Shim, Size 0, 17mm
02-029-25-2619*	Truliant Tibial Insert Trial Shim, Size 0, 19mm
02-029-25-2709	Truliant Tibial Insert Trial Shim, Size 1-2.5, 9mm
02-029-25-2710	Truliant Tibial Insert Trial Shim, Size 1-2.5, 10mm
02-029-25-2711	Truliant Tibial Insert Trial Shim, Size 1-2.5, 11mm
02-029-25-2712	Truliant Tibial Insert Trial Shim, Size 1-2.5, 12mm
02-029-25-2713	Truliant Tibial Insert Trial Shim, Size 1-2.5, 13mm
02-029-25-2715	Truliant Tibial Insert Trial Shim, Size 1-2.5, 15mm
02-029-25-2717	Truliant Tibial Insert Trial Shim, Size 1-2.5, 17mm
02-029-25-2719	Truliant Tibial Insert Trial Shim, Size 1-2.5, 19mm
02-029-25-2809	Truliant Tibial Insert Trial Shim, Size 3-4.5, 9mm
02-029-25-2810	Truliant Tibial Insert Trial Shim, Size 3-4.5, 10mm
02-029-25-2811	Truliant Tibial Insert Trial Shim, Size 3-4.5, 11mm
02-029-25-2812	Truliant Tibial Insert Trial Shim, Size 3-4.5, 12mm
02-029-25-2813	Truliant Tibial Insert Trial Shim, Size 3-4.5, 13mm
02-029-25-2815	Truliant Tibial Insert Trial Shim, Size 3-4.5, 15mm
02-029-25-2817	Truliant Tibial Insert Trial Shim, Size 3-4.5, 17mm
02-029-25-2819	Truliant Tibial Insert Trial Shim, Size 3-4.5, 19mm
02-029-25-2909	Truliant Tibial Insert Trial Shim, Size 5-6, 9mm
02-029-25-2910	Truliant Tibial Insert Trial Shim, Size 5-6, 10mm
02-029-25-2911	Truliant Tibial Insert Trial Shim, Size 5-6, 11mm
02-029-25-2912	Truliant Tibial Insert Trial Shim, Size 5-6, 12mm
02-029-25-2913	Truliant Tibial Insert Trial Shim, Size 5-6, 13mm
02-029-25-2915	Truliant Tibial Insert Trial Shim, Size 5-6, 15mm
02-029-25-2917	Truliant Tibial Insert Trial Shim, Size 5-6, 17mm
02-029-25-2919	Truliant Tibial Insert Trial Shim, Size 5-6, 19mm
02-029-25-3100*	Truliant Tibial Insert Trial Top, CR Neutral, Size 0
02-029-25-3110	Truliant Tibial Insert Trial Top, CR Neutral, Size 1
02-029-25-3115	Truliant Tibial Insert Trial Top, CR Neutral, Size 1.5
02-029-25-3120	Truliant Tibial Insert Trial Top, CR Neutral, Size 2
02-029-25-3125	Truliant Tibial Insert Trial Top, CR Neutral, Size 2.5
02-029-25-3130	Truliant Tibial Insert Trial Top, CR Neutral, Size 3
02-029-25-3135	Truliant Tibial Insert Trial Top, CR Neutral, Size 3.5
02-029-25-3140	Truliant Tibial Insert Trial Top, CR Neutral, Size 4
02-029-25-3145	Truliant Tibial Insert Trial Top, CR Neutral, Size 4.5
02-029-25-3150	Truliant Tibial Insert Trial Top, CR Neutral, Size 5
02-029-25-3160*	Truliant Tibial Insert Trial Top, CR Neutral, Size 6



**CATALOG NUMBER    PART DESCRIPTION**

02-029-25-3400\* Truliant Tibial Insert Trial Top, CRC, Size 0  
 02-029-25-3410 Truliant Tibial Insert Trial Top, CRC, Size 1  
 02-029-25-3415 Truliant Tibial Insert Trial Top, CRC, Size 1.5  
 02-029-25-3420 Truliant Tibial Insert Trial Top, CRC, Size 2  
 02-029-25-3425 Truliant Tibial Insert Trial Top, CRC, Size 2.5  
 02-029-25-3430 Truliant Tibial Insert Trial Top, CRC, Size 3  
 02-029-25-3435 Truliant Tibial Insert Trial Top, CRC, Size 3.5  
 02-029-25-3440 Truliant Tibial Insert Trial Top, CRC, Size 4  
 02-029-25-3445 Truliant Tibial Insert Trial Top, CRC, Size 4.5  
 02-029-25-3450 Truliant Tibial Insert Trial Top, CRC, Size 5  
 02-029-25-3460\* Truliant Tibial Insert Trial Top, CRC, Size 6



02-029-25-3500\* Truliant Tibial Insert Trial Top, PS, Size 0  
 02-029-25-3510 Truliant Tibial Insert Trial Top, PS, Size 1  
 02-029-25-3515 Truliant Tibial Insert Trial Top, PS, Size 1.5  
 02-029-25-3520 Truliant Tibial Insert Trial Top, PS, Size 2  
 02-029-25-3525 Truliant Tibial Insert Trial Top, PS, Size 2.5  
 02-029-25-3530 Truliant Tibial Insert Trial Top, PS, Size 3  
 02-029-25-3535 Truliant Tibial Insert Trial Top, PS, Size 3.5  
 02-029-25-3540 Truliant Tibial Insert Trial Top, PS, Size 4  
 02-029-25-3545 Truliant Tibial Insert Trial Top, PS, Size 4.5  
 02-029-25-3550 Truliant Tibial Insert Trial Top, PS, Size 5  
 02-029-25-3560\* Truliant Tibial Insert Trial Top, PS, Size 6



02-029-25-3600\* Truliant Tibial Insert Trial Top, PSC, Size 0  
 02-029-25-3610 Truliant Tibial Insert Trial Top, PSC, Size 1  
 02-029-25-3615 Truliant Tibial Insert Trial Top, PSC, Size 1.5  
 02-029-25-3620 Truliant Tibial Insert Trial Top, PSC, Size 2  
 02-029-25-3625 Truliant Tibial Insert Trial Top, PSC, Size 2.5  
 02-029-25-3630 Truliant Tibial Insert Trial Top, PSC, Size 3  
 02-029-25-3635 Truliant Tibial Insert Trial Top, PSC, Size 3.5  
 02-029-25-3640 Truliant Tibial Insert Trial Top, PSC, Size 4  
 02-029-25-3645 Truliant Tibial Insert Trial Top, PSC, Size 4.5  
 02-029-25-3650 Truliant Tibial Insert Trial Top, PSC, Size 5  
 02-029-25-3660\* Truliant Tibial Insert Trial Top, PSC, Size 6



02-029-29-1000 Truliant Tibial Trial Handle



02-029-19-2000 Truliant CR Femoral Peg Drill



02-029-90-4200 Truliant Syringe Pin Puller



## INSTRUMENT LISTING

### CATALOG NUMBER PART DESCRIPTION

02-029-90-4300

Headed Pin, Short



02-029-90-4310

Headed Pin, Long



02-029-22-1000

Truliant Tibial Pilot Drill Guide



02-029-22-1100

Truliant Tibial Pilot Drill



02-029-22-1200

Truliant Tibial Pilot Drill Stop



02-029-22-2000

Truliant Tibial Tamp Guide



02-029-22-2100

Truliant Tibial Tamp Head, cemented

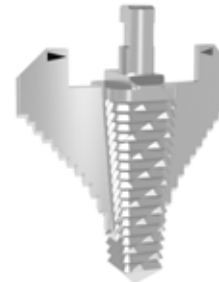

02-029-90-5000

Truliant Caliper



02-029-32-1000

Truliant Patella Prep Handle



02-029-32-1100

Spiked Patella Prep Handle\*

02-029-32-2026

Truliant Patella Drill Guide, 26mm

02-029-32-2029

Truliant Patella Drill Guide, 29mm

02-029-32-2032

Truliant Patella Drill Guide, 32mm

02-029-32-2035

Truliant Patella Drill Guide, 35mm

02-029-32-2038

Truliant Patella Drill Guide, 38mm

02-029-32-2041

Truliant Patella Drill Guide, 41mm



02-029-32-3126

Truliant Advanced Patella Drill Guide, 26mm\*

02-029-32-3129

Truliant Advanced Patella Drill Guide, 29mm\*

02-029-32-3132

Truliant Advanced Patella Drill Guide, 32mm\*

02-029-32-3135

Truliant Advanced Patella Drill Guide, 35mm\*





## INSTRUMENT LISTING

CATALOG NUMBER	PART DESCRIPTION
02-029-32-4000	Truliant Patella Drill, 3-peg, Zimmer Hudson
02-029-35-1026	3-Peg Patella Trial, 26mm
02-029-35-1029	3-Peg Patella Trial, 29mm
02-029-35-1032	3-Peg Patella Trial, 32mm
02-029-35-1035	3-Peg Patella Trial, 35mm
02-029-35-1038	3-Peg Patella Trial, 38mm
02-029-35-1041	3-Peg Patella Trial, 41mm
02-029-35-2026	3-Peg Advanced Patella Trial, 26mm*
02-029-35-2029	3-Peg Advanced Patella Trial, 29mm*
02-029-35-2032	3-Peg Advanced Patella Trial, 32mm*
02-029-35-2035	3-Peg Advanced Patella Trial, 35mm*
02-029-90-3000	Truliant Slap Hammer
02-029-19-1200	Truliant Femoral Trial Extractor
02-029-29-3200	Truliant Tibial Impactor, Locking
02-029-25-4000*	Truliant Tibial Implant Adaptor Plate, Size 0
02-029-25-4010	Truliant Tibial Implant Adaptor Plate, Size 1
02-029-25-4015	Truliant Tibial Implant Adaptor Plate, Size 1.5
02-029-25-4020	Truliant Tibial Implant Adaptor Plate, Size 2
02-029-25-4025	Truliant Tibial Implant Adaptor Plate, Size 2.5
02-029-25-4030	Truliant Tibial Implant Adaptor Plate, Size 3
02-029-25-4035	Truliant Tibial Implant Adaptor Plate, Size 3.5
02-029-25-4040	Truliant Tibial Implant Adaptor Plate, Size 4
02-029-25-4045	Truliant Tibial Implant Adaptor Plate, Size 4.5
02-029-25-4050	Truliant Tibial Implant Adaptor Plate, Size 5
02-029-25-4060*	Truliant Tibial Implant Adaptor Plate, Size 6
02-029-39-1000	Truliant Patella Clamp Head



## INSTRUMENT LISTING

### CATALOG NUMBER PART DESCRIPTION

02-029-29-3300 Truliant Tibial Insert Driver



02-029-29-3000 Truliant Tibial Impactor, Non-locking, Small



02-029-29-3100 Truliant Tibial Non-Locking Impactor, Large



02-029-90-4000 Truliant Pin Puller



207-80-10 LBS-3 Tensor  
521-50-08 LBS-3 Tensor (with augment slots)



02-029-42-1000 Truliant LBS-3 Adaptor, Posterior Body



**CATALOG NUMBER    PART DESCRIPTION**

02-029-42-1100      Truliant LBS-3 Adaptor, Anterior Body



02-029-42-1200      Truliant LBS-3 Adaptor, Stylus\*



02-029-90-8123      Truliant 2° Varus/Valgus Re-Cut Referencer



02-029-90-8002      Truliant 2mm Re-Cut Referencer



02-029-99-1101      Pin Driver, Square-Headed

02-029-99-1003      Short-Headed Screw, 1.0"



02-029-99-1004      Short-Headed Screw, 1.2"



- 02-029-25-1100      Truliant Porous Tibial Baseplate Trial, 0T
- 02-029-25-1105      Truliant Porous Tibial Baseplate Trial, 0.5T
- 02-029-25-1110      Truliant Porous Tibial Baseplate Trial, 1T
- 02-029-25-1115      Truliant Porous Tibial Baseplate Trial, 1.5T
- 02-029-25-1120      Truliant Porous Tibial Baseplate Trial, 2T
- 02-029-25-1125      Truliant Porous Tibial Baseplate Trial, 2.5T
- 02-029-25-1130      Truliant Porous Tibial Baseplate Trial, 3T
- 02-029-25-1135      Truliant Porous Tibial Baseplate Trial, 3.5T
- 02-029-25-1140      Truliant Porous Tibial Baseplate Trial, 4T
- 02-029-25-1145      Truliant Porous Tibial Baseplate Trial, 4.5T
- 02-029-25-1150      Truliant Porous Tibial Baseplate Trial, 5T
- 02-029-25-1155      Truliant Porous Tibial Baseplate Trial, 5.5T
- 02-029-25-1160      Truliant Porous Tibial Baseplate Trial, 6T

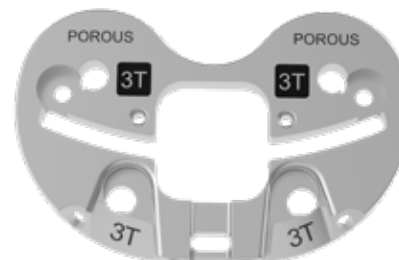

## INSTRUMENT LISTING

### CATALOG NUMBER PART DESCRIPTION

02-029-22-1310 Truliant Porous Tibial Drill Guide, Small  
02-029-22-1320 Truliant Porous Tibial Drill Guide, Medium  
02-029-22-1330 Truliant Porous Tibial Drill Guide, Large



02-029-22-1600 Truliant Porous Tibial Pilot Drill, 14mm



02-029-22-1500 Truliant Porous Tibia Peg Drill



02-029-22-2200 Truliant Porous Tibial Tamp Head



1FL2-C01 Truliant Universal Modular Handle



02-029-29-4000 Truliant Porous Bone Screw Drill Guide



02-029-90-7000 Truliant Hex Driver, 3.5mm





# TRAY LAYOUTS

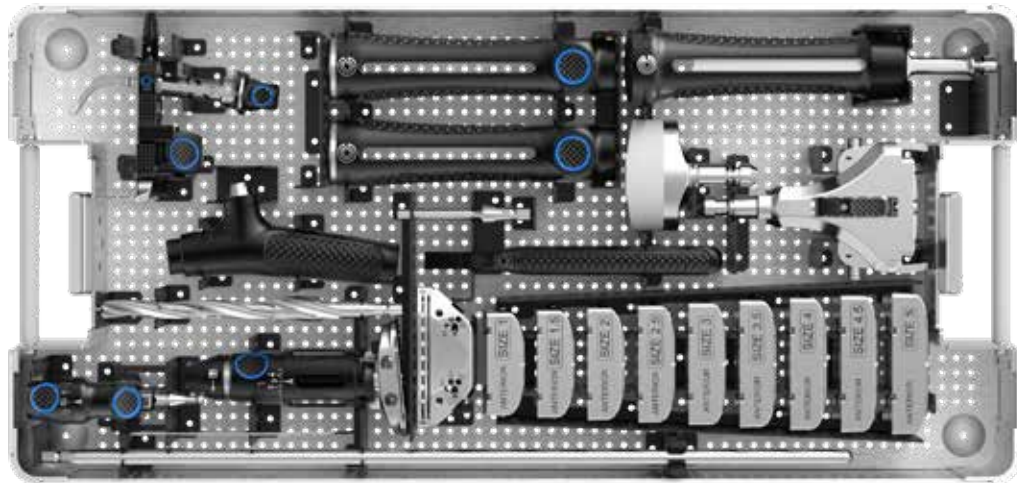

**KIT-271A TRULIANT FEMORAL PREP INSTRUMENT TRAY**

Item	Item Description	Qty
02-029-11-2000	Varus/Valgus Alignment Guide	1
02-029-11-2100	Distal Link	1
02-029-11-8000	Distal Femoral Cut Block	1
02-029-11-1000	Im Pilot Drill	1
02-029-11-1100	Im Rod	1
02-029-11-1300	Modular T-Handle	1
02-029-12-1200	A/P Sizer	1
02-029-19-1000	Locking Femoral Impactor	1
02-029-19-1100	Non-Locking Femoral Impactor	1
02-029-90-1000	Modular Handle	2
02-029-90-4000	Pin Puller	1
02-029-90-6000	Angel Wing	1
02-029-13-8010	Size 1, 4-in-1 Block	1
02-029-13-8015	Size 1.5, 4-in-1 Block	1
02-029-13-8020	Size 2, 4-in-1 Block	1
02-029-13-8025	Size 2.5, 4-in-1 Block	1
02-029-13-8030	Size 3, 4-in-1 Block	1
02-029-13-8035	Size 3.5, 4-in-1 Block	1
02-029-13-8040	Size 4, 4-in-1 Block	1
02-029-13-8045	Size 4.5, 4-in-1 Block	1
02-029-13-8050	Size 5, 4-in-1 Block	1
02-029-90-3000	Slaphammer	1

## TRAY LAYOUTS

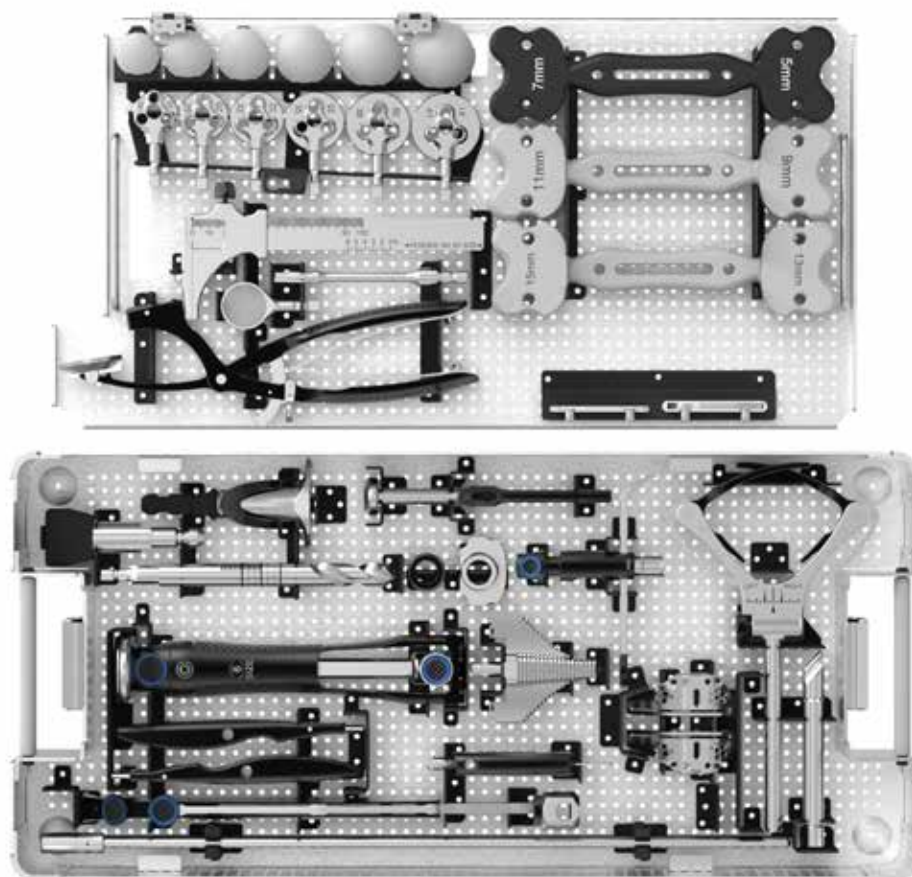

### KIT-271B TRULIANT TIBIAL/PATELLA® PREP INSTRUMENT TRAY

Item	Item Description	Qty
02-029-90-2010	Spacer Block, 9/11	1
02-029-90-2020	Spacer Block, 13/15	1
02-029-90-2040	Spacer Block, 5/7	1
02-029-90-2100	1mm Shim for Spacer Blocks	1
02-029-90-2120	4mm Shim for Spacer Blocks	1
02-029-90-4200	Syringe Pin Puller	1
02-029-21-1000	Ankle Clamp	1
02-029-21-1100	EM Alignment Guide	1
02-029-21-4000	Tibial Stylus	1
02-029-21-8010	Tibial Cut Block, Left	1
02-029-21-8020	Tibial Cut Block, Right	1
02-029-22-1100	14mm Tibial Pilot Drill	1



**KIT-271B TRULIANT TIBIAL/PATELLA PREP INSTRUMENT TRAY (CONT.)**

02-029-22-1000	Tibial Pilot Drill Guide	1
02-029-22-1200	Pilot Drill Stopper	1
02-029-22-2000	Tamp Guide	1
02-029-22-2100	Tamp Head	1
02-029-29-3200	Tibial Locking Impactor	1
02-029-29-1000	Tibial Trial Handle	2
02-029-32-2026	Patella Drill Guide, 26mm	1
02-029-32-2029	Patella Drill Guide, 29mm	1
02-029-32-2032	Patella Drill Guide, 32mm	1
02-029-32-2035	Patella Drill Guide, 35mm	1
02-029-32-2038	Patella Drill Guide, 38mm	1
02-029-32-2041	Patella Drill Guide, 41mm	1
02-029-32-1000	Patella Clamp	1
02-029-32-4000	Patella Drill, 3 Peg	1
02-029-39-1000	Patelar Compression Head	1
02-029-90-5000	Caliper	1
02-029-35-1026	3 Peg Patella Trial, 26mm	1
02-029-35-1029	3 Peg Patella Trial, 29mm	1
02-029-35-1032	3 Peg Patella Trial, 32mm	1
02-029-35-1035	3 Peg Patella Trial, 35mm	1
02-029-35-1038	3 Peg Patella Trial, 38mm	1
02-029-35-1041	3 Peg Patella Trial, 41mm	1
02-029-29-2000	Drop Rod	1
02-029-29-2100	Drop Rod Extension	1
02-029-29-1100	Drop Rod Handle	1
02-029-29-3300	Tibial Insert Driver	1
02-029-29-3000	Tibial Non Locking Impactor	1

## TRAY LAYOUTS

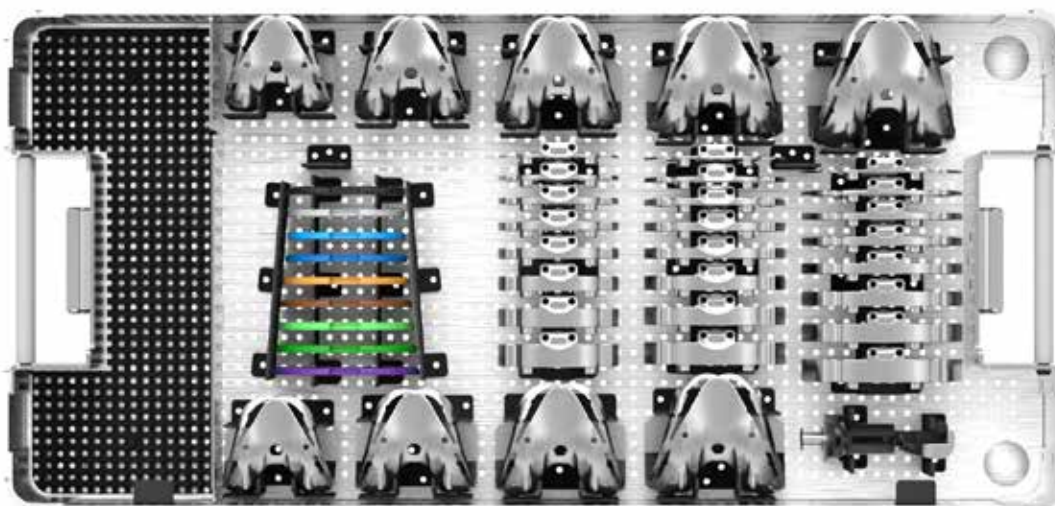

### KIT-271C TRULIANT UNIVERSAL TRIALS INSTRUMENT TRAY

Item	Item Description	Qty
02-029-15-1010	Modular Femoral Trial, Size 1	1
02-029-15-1015	Modular Femoral Trial, Size 1.5	1
02-029-15-1020	Modular Femoral Trial, Size 2	1
02-029-15-1025	Modular Femoral Trial, Size 2.5	1
02-029-15-1030	Modular Femoral Trial, Size 3	1
02-029-15-1035	Modular Femoral Trial, Size 3.5	1
02-029-15-1040	Modular Femoral Trial, Size 4	1
02-029-15-1045	Modular Femoral Trial, Size 4.5	1
02-029-15-1050	Modular Femoral Trial, Size 5	1
02-029-25-1005	Tray Trial, Size 0.5	1
02-029-25-1010	Tray Trial, Size 1	1
02-029-25-1015	Tray Trial, Size 1.5	1
02-029-25-1020	Tray Trial, Size 2	1
02-029-25-1025	Tray Trial, Size 2.5	1
02-029-25-1030	Tray Trial, Size 3	1
02-029-25-1035	Tray Trial, Size 3.5	1
02-029-25-1040	Tray Trial, Size 4	1
02-029-25-1045	Tray Trial, Size 4.5	1
02-029-25-1050	Tray Trial, Size 5	1
02-029-25-1055	Tray Trial, Size 5.5	1
02-029-25-4010	Tibial Trial/Implant Adaptor Plate, Size 1	1
02-029-25-4015	Tibial Trial/Implant Adaptor Plate, Size 1.5	1
02-029-25-4020	Tibial Trial/Implant Adaptor Plate, Size 2	1
02-029-25-4025	Tibial Trial/Implant Adaptor Plate, Size 2.5	1
02-029-25-4030	Tibial Trial/Implant Adaptor Plate, Size 3	1
02-029-25-4035	Tibial Trial/Implant Adaptor Plate, Size 3.5	1
02-029-25-4040	Tibial Trial/Implant Adaptor Plate, Size 4	1
02-029-25-4045	Tibial Trial/Implant Adaptor Plate, Size 4.5	1
02-029-25-4050	Tibial Trial/Implant Adaptor Plate, Size 5	1

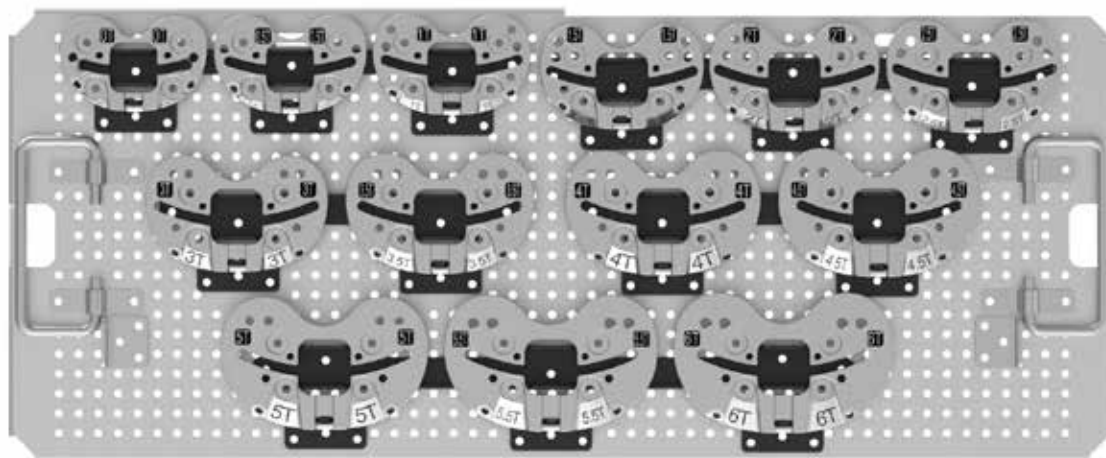

**KIT-271C TRULIANT UNIVERSAL TRIALS INSTRUMENT TRAY (CONT.)**

02-029-25-2709	Truliant Tibial Insert Trial Shim, Size 1-2.5, 9mm	1
02-029-25-2710	Truliant Tibial Insert Trial Shim, Size 1-2.5, 10mm	1
02-029-25-2711	Truliant Tibial Insert Trial Shim, Size 1-2.5, 11mm	1
02-029-25-2712	Truliant Tibial Insert Trial Shim, Size 1-2.5, 12mm	1
02-029-25-2713	Truliant Tibial Insert Trial Shim, Size 1-2.5, 13mm	1
02-029-25-2715	Truliant Tibial Insert Trial Shim, Size 1-2.5, 15mm	1
02-029-25-2717	Truliant Tibial Insert Trial Shim, Size 1-2.5, 17mm	1
02-029-25-2719	Truliant Tibial Insert Trial Shim, Size 1-2.5, 19mm	1
02-029-25-2809	Truliant Tibial Insert Trial Shim, Size 3-4.5, 9mm	1
02-029-25-2810	Truliant Tibial Insert Trial Shim, Size 3-4.5, 10mm	1
02-029-25-2811	Truliant Tibial Insert Trial Shim, Size 3-4.5, 11mm	1
02-029-25-2812	Truliant Tibial Insert Trial Shim, Size 3-4.5, 12mm	1
02-029-25-2813	Truliant Tibial Insert Trial Shim, Size 3-4.5, 13mm	1
02-029-25-2815	Truliant Tibial Insert Trial Shim, Size 3-4.5, 15mm	1
02-029-25-2817	Truliant Tibial Insert Trial Shim, Size 3-4.5, 17mm	1
02-029-25-2819	Truliant Tibial Insert Trial Shim, Size 3-4.5, 19mm	1
02-029-25-2909	Truliant Tibial Insert Trial Shim, Size 5-6, 9mm	1
02-029-25-2910	Truliant Tibial Insert Trial Shim, Size 5-6, 10mm	1
02-029-25-2911	Truliant Tibial Insert Trial Shim, Size 5-6, 11mm	1
02-029-25-2912	Truliant Tibial Insert Trial Shim, Size 5-6, 12mm	1
02-029-25-2913	Truliant Tibial Insert Trial Shim, Size 5-6, 13mm	1
02-029-25-2915	Truliant Tibial Insert Trial Shim, Size 5-6, 15mm	1
02-029-25-2917	Truliant Tibial Insert Trial Shim, Size 5-6, 17mm	1
02-029-25-2919	Truliant Tibial Insert Trial Shim, Size 5-6, 19mm	1
02-029-19-1200	Femoral Trial Extractor	1

## TRAY LAYOUTS

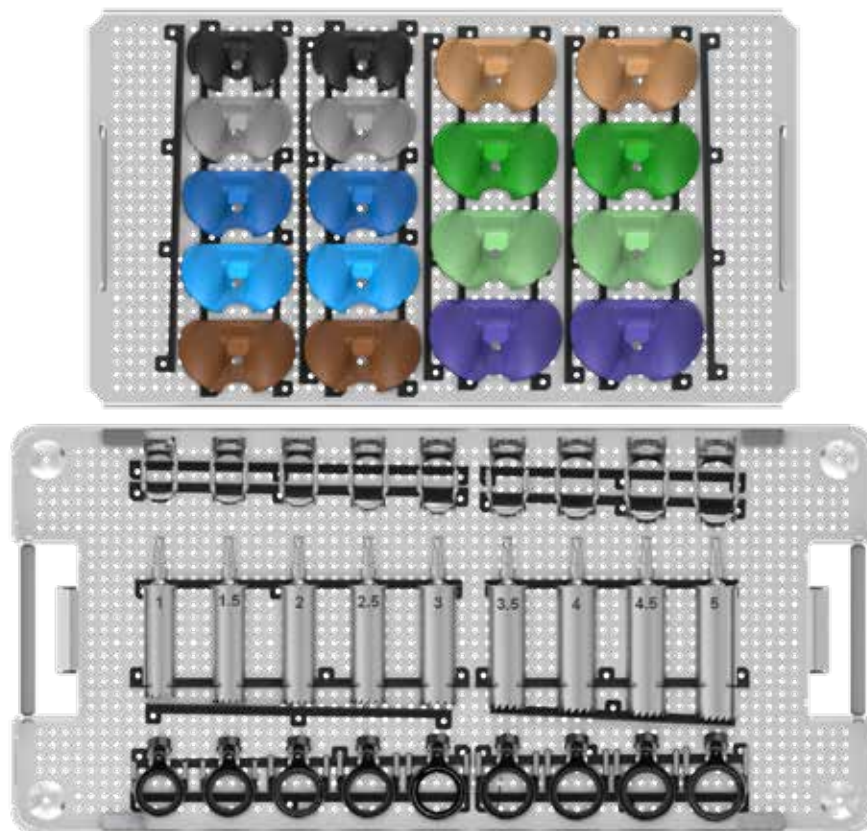

### KIT-275PS TRULIANT PS INSTRUMENT TRAY

Item	Item Description	Qty
02-029-15-2010	PS Modular Notch Guide, Size 1	1
02-029-15-2015	PS Modular Notch Guide, Size 1.5	1
02-029-15-2020	PS Modular Notch Guide, Size 2	1
02-029-15-2025	PS Modular Notch Guide, Size 2.5	1
02-029-15-2030	PS Modular Notch Guide, Size 3	1
02-029-15-2035	PS Modular Notch Guide, Size 3.5	1
02-029-15-2040	PS Modular Notch Guide, Size 4	1
02-029-15-2045	PS Modular Notch Guide, Size 4.5	1
02-029-15-2050	PS Modular Notch Guide, Size 5	1
02-029-15-3010	PS Notch Reamer, Size 1	1
02-029-15-3015	PS Notch Reamer, Size 1.5	1
02-029-15-3020	PS Notch Reamer, Size 2	1
02-029-15-3025	PS Notch Reamer, Size 2.5	1
02-029-15-3030	PS Notch Reamer, Size 3	1

**KIT-275PS TRULIANT PS INSTRUMENT TRAY (CONT.)**

02-029-15-3035	PS Notch Reamer, Size 3.5	1
02-029-15-3040	PS Notch Reamer, Size 4	1
02-029-15-3045	PS Notch Reamer, Size 4.5	1
02-029-15-3050	PS Notch Reamer, Size 5	1
02-029-15-4010	PS Box Trial, Size 1	1
02-029-15-4015	PS Box Trial, Size 1.5	1
02-029-15-4020	PS Box Trial, Size 2	1
02-029-15-4025	PS Box Trial, Size 2.5	1
02-029-15-4030	PS Box Trial, Size 3	1
02-029-15-4035	PS Box Trial, Size 3.5	1
02-029-15-4040	PS Box Trial, Size 4	1
02-029-15-4045	PS Box Trial, Size 4.5	1
02-029-15-4050	PS Box Trial, Size 5	1
02-029-25-3510	PS Size 1 Insert Trial Topper	2
02-029-25-3515	PS Size 1.5 Insert Trial Topper	2
02-029-25-3520	PS Size 2 Insert Trial Topper	2
02-029-25-3525	PS Size 2.5 Insert Trial Topper	2
02-029-25-3530	PS Size 3 Insert Trial Topper	2
02-029-25-3535	PS Size 3.5 Insert Trial Topper	2
02-029-25-3540	PS Size 4 Insert Trial Topper	2
02-029-25-3545	PS Size 4.5 Insert Trial Topper	2
02-029-25-3550	PS Size 5 Insert Trial Topper	2

## TRAY LAYOUTS

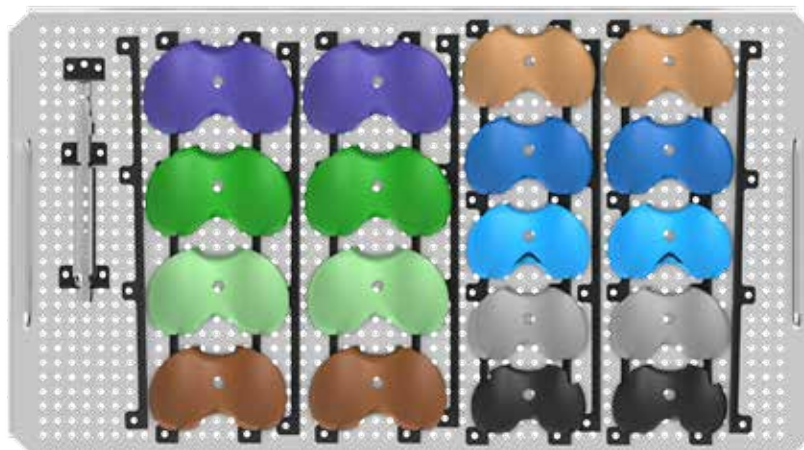

### KIT-273CR TRULIANT CR INSTRUMENT TRAY

Item	Item Description	Qty
02-029-25-3110	Tibial Insert Trial Topper, CR Neutral, Size 1	2
02-029-25-3115	Tibial Insert Trial Topper, CR Neutral, Size 1.5	2
02-029-25-3120	Tibial Insert Trial Topper, CR Neutral, Size 2	2
02-029-25-3125	Tibial Insert Trial Topper, CR Neutral, Size 2.5	2
02-029-25-3130	Tibial Insert Trial Topper, CR Neutral, Size 3	2
02-029-25-3135	Tibial Insert Trial Topper, CR Neutral, Size 3.5	2
02-029-25-3140	Tibial Insert Trial Topper, CR Neutral, Size 4	2
02-029-25-3145	Tibial Insert Trial Topper, CR Neutral, Size 4.5	2
02-029-25-3150	Tibial Insert Trial Topper, CR Neutral, Size 5	2
02-029-19-2000	CR Femoral Peg Drill	1

**KIT-275PSC TRULIANT PSC INSTRUMENT TRAY**

<b>Item</b>	<b>Item Description</b>	<b>Qty</b>
02-029-25-3610	PSC Size 1, Insert Trial Topper	2
02-029-25-3615	PSC Size 1.5, Insert Trial Topper	2
02-029-25-3620	PSC Size 2, Insert Trial Topper	2
02-029-25-3625	PSC Size 2.5, Insert Trial Topper	2
02-029-25-3630	PSC Size 3, Insert Trial Topper	2
02-029-25-3635	PSC Size 3.5, Insert Trial Topper	2
02-029-25-3640	PSC Size 4, Insert Trial Topper	2
02-029-25-3645	PSC Size 4.5, Insert Trial Topper	2
02-029-25-3650	PSC Size 5, Insert Trial Topper	2

**KIT-273CRC TRULIANT CRC INSTRUMENT TRAY**

<b>Item</b>	<b>Item Description</b>	<b>Qty</b>
02-029-25-3410	Tibial Insert Trial Topper, CRC, Size 1	2
02-029-25-3415	Tibial Insert Trial Topper, CRC, Size 1.5	2
02-029-25-3420	Tibial Insert Trial Topper, CRC, Size 2	2
02-029-25-3425	Tibial Insert Trial Topper, CRC, Size 2.5	2
02-029-25-3430	Tibial Insert Trial Topper, CRC, Size 3	2
02-029-25-3435	Tibial Insert Trial Topper, CRC, Size 3.5	2
02-029-25-3440	Tibial Insert Trial Topper, CRC, Size 4	2
02-029-25-3445	Tibial Insert Trial Topper, CRC, Size 4.5	2
02-029-25-3450	Tibial Insert Trial Topper, CRC, Size 5	2
02-029-19-2000	Truliant CR Femoral Peg Drill	1

**OPT-271\_0 TRULIANT SIZE 0 INSTRUMENT TRAY**

<b>Item</b>	<b>Item Description</b>	<b>Qty</b>
02-029-13-8000	DF 4-in-1 Cutting Block, Size 0	1



## TRAY LAYOUTS

02-029-15-1000	Universal Femoral Trial, Size 0	1
02-029-25-1000	Tibial Baseplate Trial, 0T	1
02-029-25-2009	Tibial Insert Trial Shim, Size 0, 9mm	1
02-029-25-2010	Tibial Insert Trial Shim, Size 0, 10mm	1
02-029-25-2011	Tibial Insert Trial Shim, Size 0, 11mm	1
02-029-25-2012	Tibial Insert Trial Shim, Size 0, 12mm	1
02-029-25-2013	Tibial Insert Trial Shim, Size 0, 13mm	1
02-029-25-2015	Tibial Insert Trial Shim, Size 0, 15mm	1
02-029-25-2017	Tibial Insert Trial Shim, Size 0, 17mm	1
02-029-25-2019	Tibial Insert Trial Shim, Size 0, 19mm	1
02-029-25-3100	Tibial Insert Trial Topper, CR Neutral, Size 0	2
02-029-25-3400	Tibial Insert Trial Topper, CRC, Size 0	2
02-029-25-3500	Tibial Insert Trial Topper, PS, Size 0	2
02-029-25-3600	Tibial Insert Trial Topper, PSC, Size 0	2
02-029-25-4000	Tibial Trial/Implant Adaptor Plate, Size 0	1
02-029-15-2000	Modular PS Notch Guide, Size 0	1
02-029-15-3000	PS Notch Reamer, Size 0	1
02-029-15-4000	Modular PS Cam, Size 0	1

### OPT-271\_6 TRULIANT SIZE 6 INSTRUMENT TRAY

Item	Item Description	Qty
02-029-13-8060	DF 4-in-1 Cutting Block, Size 6	1
02-029-15-1060	Universal Femoral Trial, Size 6	1
02-029-25-1060	Tibial Baseplate Trial, 6T	1
02-029-25-3160	Tibial Insert Trial Topper, CR Neutral, Sz 6	2
02-029-25-3460	Tibial Insert Trial Topper, CRC, Sz 6	2
02-029-25-3560	Tibial Insert Trial Topper, PS, Sz 6	2
02-029-25-3660	Tibial Insert Trial Topper, PSC, Sz 6	2
02-029-25-4060	Tibial Trial/Implant Adaptor Plate, Sz 6	1
02-029-15-2060	Modular PS Notch Guide , Size 6	1
02-029-15-3060	PS Notch Reamer, Size 6	1
02-029-15-4060	Modular PS Cam, Size 6	1



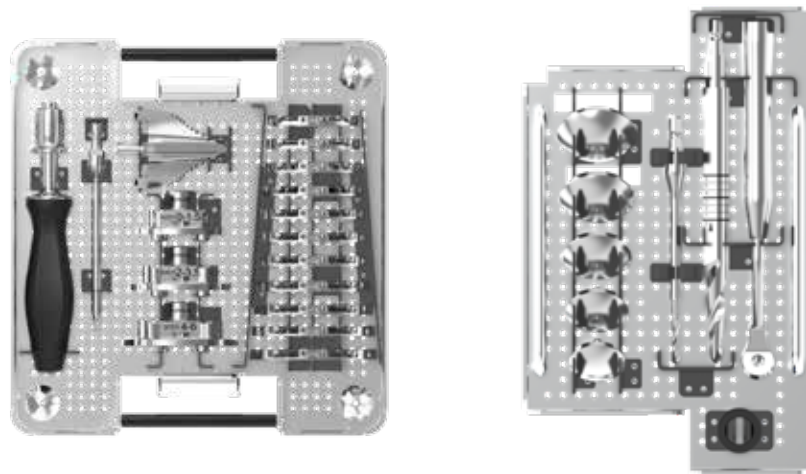

**OPT-271\_6 TRULIANT SIZE 6 INSTRUMENT TRAY**

Item	Item Description	Qty
02-029-22-1200	Truliant Tibial Pilot Drill Stop 14mm	1
02-029-22-1310	Truliant Porous Tib Drill Guide, Small	1
02-029-22-1320	Truliant Porous Tib Drill Guide, Medium	1
02-029-22-1330	Truliant Porous Tib Drill Guide, Large	1
02-029-22-1500	Truliant Porous Tibia Peg Drill	1
02-029-22-1600	Pilot Drill, 14mm Truliant Porous Tibia	1
02-029-22-2200	Truliant Porous Tamp Head	1
02-029-25-1105	Truliant Porous Baseplate Size 0.5	1
02-029-25-1110	Truliant Porous Baseplate Size 1	1
02-029-25-1115	Truliant Porous Baseplate Size 1.5	1
02-029-25-1120	Truliant Porous Baseplate Size 2	1
02-029-25-1125	Truliant Porous Baseplate Size 2.5	1
02-029-25-1130	Truliant Porous Baseplate Size 3	1
02-029-25-1135	Truliant Porous Baseplate Size 3.5	1
02-029-25-1140	Truliant Porous Baseplate Size 4	1
02-029-25-1145	Truliant Porous Baseplate Size 4.5	1
02-029-25-1150	Truliant Porous Baseplate Size 5	1
02-029-25-1155	Truliant Porous Baseplate Size 5.5	1
02-029-90-7000	Truliant Hex Driver 3.5mm	1
1FL2-C01	Truliant Modular Handle Z-Hudson Connection	1





Exactech, Inc. is proud to have offices and distributors around the globe. For more information about Exactech products available in your country, please visit [www.exac.com](http://www.exac.com)

---

For additional device information, refer to the Truliant Knee System—Instructions for Use for a device description, indications, contraindications, precautions and warnings. For further product information, please contact Customer Service, Exactech, Inc., 2320 NW 66th Court, Gainesville, Florida 32653-1630, USA. (352) 377-1140, (800) 392-2832 or FAX (352) 378-2617.

Exactech, as the manufacturer of this device, does not practice medicine, and is not responsible for recommending the appropriate surgical technique for use on a particular patient. These guidelines are intended to be solely informational and each surgeon must evaluate the appropriateness of these guidelines based on his or her personal medical training and experience. Prior to use of this system, the surgeon should refer to the product package insert for comprehensive warnings, precautions, indications for use, contraindications and adverse effects.

The products discussed herein may be available under different trademarks in different countries. All copyrights, and pending and registered trademarks, are property of Exactech, Inc. This material is intended for the sole use and benefit of the Exactech sales force and physicians. It should not be redistributed, duplicated or disclosed without the express written consent of Exactech, Inc. ©2023 Exactech, Inc. 712-35-41 Rev E 0523



CE Mark is not valid unless there is a CE Mark on the product label



**EXACTECH, INC.**  
2320 NW 66TH COURT  
GAINESVILLE, FL 32653 USA

+1 352.377.1140  
+1 800.EXACTECH  
+1 352.378.2617 (FAX)  
[www.exac.com](http://www.exac.com)